



sustainable solutions **under one roof**

HEATING / HOT WATER / VENTILATION

Publication No. ZZ 1430-8
June 2016

QUANTEC HR28C ErP

High Efficiency Boiler

with Passive Flue
Gas Heat Recovery



INSTALLATION, COMMISSIONING
& SERVICING INSTRUCTIONS

Quantec HR28C ErP - G.C. No. 47-416-11

These instructions are to be left with the User

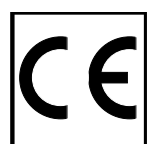

www.johnsonandstarley.co.uk

CONTENTS

The Benchmark Scheme	2	12 Electrical	21
1 Features	3	Drop Down Control Panel	
2 General Description	3	Electrical Connections	
3 Building Standards & Regulations	4	Internal Wiring	
4 Safety, Electrical & Gas Information	4	To Add Thermostat/Programmer	
General Safety Information		Thermostats & Timer Kits	
Handling the Unit		Operational System Control	
Operating the Appliance		Electrical Testing	
Electrical Supply		13 Wiring Diagram	22
Gas Supply		14 Connections & Filling	23
5 Fiche ErP Technical Data	5	Water Connection for Central Heating	
Technical Data		Condensate Drain	
Performance Data		Pressure Relief Valve	
6 Preparation	8	Filling the Boiler	
Electrical Connections		Gas Connection	
Water Connections		15 Commissioning	23
Gas Connection		Check Gas Installation	
Condensate Drain		Air Purge Function	
Boiler Control Interlock		Initial Lighting	
Thermostatic Radiator Valves		Central Heating	
Positioning		Domestic Hot Water	
Timber Frame Buildings		Check the Operational Gas Inlet Pressure	
Bathroom Installation		General Checks DHW Mode	
Compartment Installations		CH & DHW Mode	
Room Ventilation		Flushing the System & Water circulation	
7 Dimension & Clearances	10	Balance the System	
8 Heating System	11	Water Temperatures	
Expansion Vessel		16 Handing Over	27
Pressure Gauge		Instructing the User	
Pressure Relief Valve		Loss of Water Pressure	
Filling Loop		17 Servicing & Maintenance	27
Pipework Sizing		Service Schedule	
Domestic Hot Water Requirements		Initial Inspection	
Water Flow Schematic		Servicing Sequence	
9 Installation Instructions	13	Flue Inspection & Checks	
Carton Contents		Gaining Access to the Boiler	
Wall Mounting Template		Control Panel & Front Door Removal	
Fixing the Appliance		Fan Removal	
10 Flue Instructions	14	Burner Assembly Removal	
Flue Configuration		Heat Exchanger	
Diagram of Terminal Positions		Condensate Trap	
Types of Flue Systems		18 Parts Replacements	30
Flue Terminal Positions		Part Replacements without Draining the System	
Plume Outlets		Draining the Appliance & System	
Flue Requirements & General Information		19 Fault Finding Flowcharts & Blocking Codes	34
Conventional 60/100mm Flue Accessories Part No.s		20 List of Spares	39
Optional Roof Outlets		21 Benchmark Checklist and Service Record	41
The Standard Horizontal Flue System		Code of Practice	
Installation of the Standard Horizontal Flue System		Commissioning Checklist	
11 Condensate Drain	20	Service Record	
Use of a Condensate Pump to External Termination			
External Termination			
Unheated Internal Area's			

**PLEASE READ THESE INSTRUCTIONS CAREFULLY BEFORE STARTING INSTALLATION.
LEAVE THESE INSTRUCTION WITH THE USER OR AT THE GAS METER AFTER INSTALLATION**



The Benchmark Scheme

Benchmark places responsibilities on both manufacturers and installers. The purpose is to ensure that customers are provided with the correct equipment for their needs, that it is installed, commissioned and serviced in accordance with the manufacturer's instructions by competent persons and that it meets the requirements of the appropriate Building Regulations. The Benchmark Checklist can be used to demonstrate compliance with Building Regulations and should be provided to the customer for future reference.

Visit www.centralheating.co.uk for more information.

Installers are required to carry out installation, commissioning and servicing work in accordance with the Benchmark Code of Practice which is available from the Heating and Hot water Industry Council who manage and promote the Scheme.

In the interest of continuous development Johnson and Starley reserve the right to change specification without prior notice. Johnson and Starley prides itself on it's ability to supply spare parts quickly and efficiently.

1. FEATURES

Appliance Classification:

The QuanTec HR28C has been tested and CE certified by B.S.I Ltd for use with NATURAL Gas G20.

FEATURES	
1	Rain Trap
2	Flue Test Point
3	Flue Sensor
4	View Port
5	Heat Exchanger
6	Ignition/Detection Electrode
7	Flow Thermistor Sensor
8	Condensate Trap
9	Combustion Fan
10	Diverter Valve
11	Control Panel
12	Gas Valve
13	Pump
14	CH Water Pressure Sensor
15	Automatic Air Vent
16	Return Thermistor Sensor
17	Pressure Relief Valve
18	DHW Flow Sensor
19	Burner Injector
20	Venturi
21	Expansion Vessel

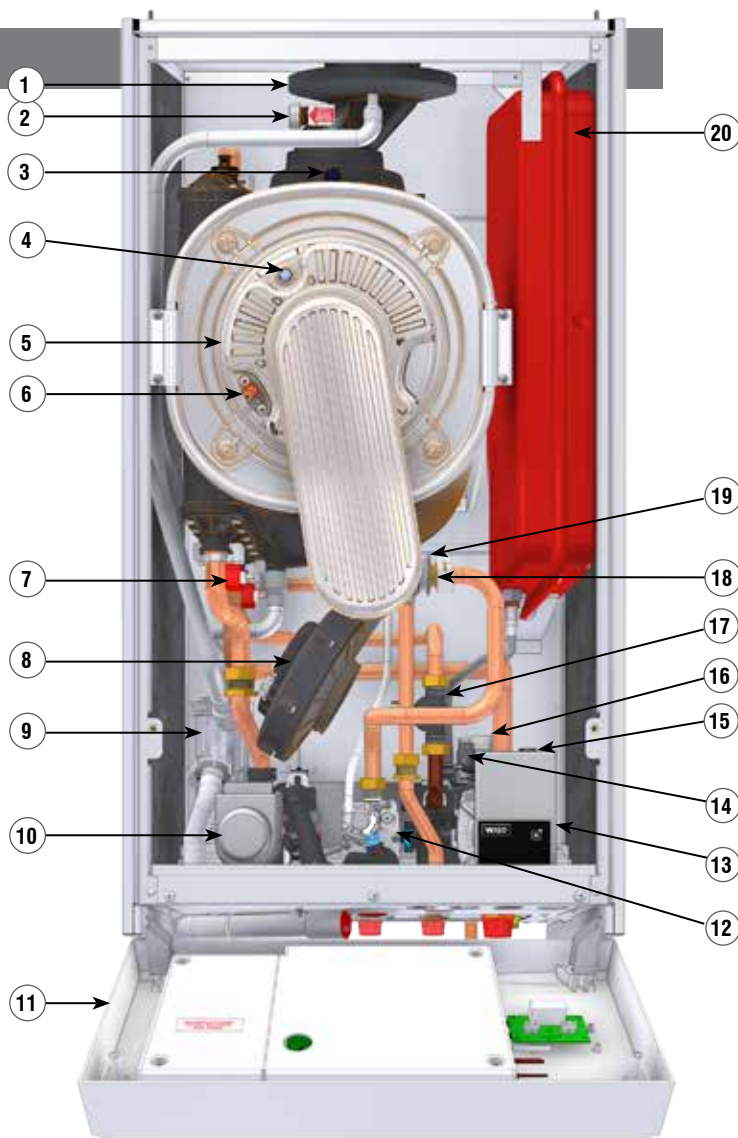

FIGURE 1. QUANTEC HR28C FEATURES

2. GENERAL DESCRIPTION

2.1 The QuanTec HR28C appliance is a high efficiency combination boiler, designed to provide both central heating and domestic hot water on demand. It's design is room sealed, taking combustion air from outside and expelling the products of combustion back to the outside.

Standard features include full sequence automatic spark ignition, low water content stainless steel heat exchanger, automatic bypass and boiler frost protection, a daily pump and divert valve excises.

The QuanTec HR28C incorporates an additional recuperator to preheat the DHW cold supply prior to being fully heated in the normal plate heat exchanger.

Variable CH and DHW temperature controls are fitted on the user control and the boiler features a DHW preheat facility.

- Central heating (CH) output is fully modulating with a range of: 4.8 to 24.2kW (16,500 to 82,600 Btu/h)
- Instant domestic hot water (DHW) output is also fully modulating with a maximum of: 23.07kW.

2.2 When no demand for CH, the boiler fires only when DHW is drawn off, or periodically for a few seconds without any DHW draw-off, in order to maintain the DHW calorifier in a heated condition. This only occurs if pre-heat is in the 'ON' period.

When there is a demand for CH, the heating system is supplied at the selected temperature of between 45°C and 80°C, until DHW is drawn off. The full output from the boiler is then directed via the diverter valve to the plate heat exchanger to supply a nominal DHW draw-off of 12.31 l/min at 35°C temperature rise.

The DHW draw off rate specified above is the nominal that the boiler flow regulator will give. Due to system variations and seasonal temperatures DHW flow rates/temperature rise will vary, requiring adjustment at the draw off tap.

At low DHW draw-off rate the maximum temperature is limited to 65°C by the modulating gas control.

The boiler features a comprehensive diagnostic system which gives detailed information on the boiler status when operating, and performance of key components to aid commissioning and fault finding.

3. BUILDING STANDARDS & REGULATIONS



STATUTE LAW DEFINES THAT ALL GAS APPLIANCES MUST BE INSTALLED BY COMPETENT PERSONS, i.e. GAS SAFE REGISTERED INSTALLERS.
GAS SAFE MEMBERSHIP ENQUIRIES TEL: 0800 408 5500 IN ACCORDANCE WITH THE GAS SAFETY (INSTALLATION AND USE) REGULATIONS (CURRENT EDITION).
FAILURE TO COMPLY WITH THESE REGULATIONS MAY LEAD TO PROSECUTION.



3.1 INSTALLATION REGULATIONS

- Building Standards (Scotland) (Consolidation) Regulations
- Building Regulation Part L
- Gas Safety (Installation and Use) Regulations (as amended)
- The Water Fittings Regulations or Water by-laws in Scotland
- Building Regulation (Northern Ireland)
- Model and Local Authority Byelaws
- Health & Safety Document No. 635.
- The Electricity at Work Regulations, 1989.
- Institute of Electrical Engineers (I.E.E) Wiring Regulations
- EU Regulation No 811/2013 and No. 812/2013 supplement Directive 2013/20/EU

This appliance has been Tested and Certified in order to meet the necessary European Directives and comply with the latest Building Regulations, including the efficiency requirements of the SEDBUK scheme.

- Efficiency of Hot Water Boilers Directive 92/42/EEC
- Gas Appliance Directive 2009/142/EC
- Low Voltage Directive 2006/95/EEC
- Electromagnetic Compatibility Directive 93/68/EEC

3.2 BUILDING STANDARDS AND REGULATIONS

Where no specific instructions are given, reference should be made to the relevant British Standard Code of Practice.

- BS 5440:1** Flues (for gas appliances of rated input not exceeding 70 kW).
- BS 5440:2** Ventilation (for gas appliances of rated input not exceeding 70 kW).
- BS EN 12828** Heating Systems in buildings: Design for water based heating systems.
- BS EN 12831** Heating Systems in buildings: Method for calculation of the design heat load.
- BS EN 14336** Heating Systems in buildings: Installation and commissioning of water based heating systems.
- BS 5546** Installation of gas hot water supplies for domestic purposes (2nd Family Gases)
- BS 6798** Installation of gas fired hot water boilers of rated input not exceeding 70 kW.
- BS 6891** Installation of Low Pressure Gas Pipework of up to 28 mm (R1) in domestic premises (2nd family gases).

IMPORTANT: This appliance is CE certificated for safety and performance. It is important that no modifications are made to this appliance, unless fully approved in writing by Johnson & Starley Ltd. If in doubt please ring Johnson & Starley Ltd on Telephone 01604 762881.

4. SAFETY ELECTRICAL & GAS INFORMATION

PLEASE READ THESE INSTRUCTIONS CAREFULLY BEFORE COMMENCING WITH THE INSTALLATION

4.1 GENERAL SAFETY INFORMATION

- 4.1.1 An LPG unit should not be installed in a room or internal space below ground level unless one side of the sides of the building is open to the ground.
- 4.1.2 Only use QuanTec original spare parts on this appliance. Failure to do so will invalidate the guarantee.
- 4.1.3 No artificially softened water must not be used to fill the central heating system.
- 4.1.4 The system can be damaged by debris entering the heat exchanger and reduce efficiency. It is recommended that the boiler is flushed, follow these guidelines as this will protect the boiler and prolong its life.
- 4.1.5 It is important that the system is flushed thoroughly before the appliance is left to operate (as recommended in BS 7593) in order to maintain an efficiently operating heating system. For replacement installations, the system MUST be flushed with the old boiler in situ, in order to prevent the QuanTec becoming a trap for system debris. Once the system has been flushed, an inhibitor (suitable for stainless steel heat exchangers) should be added. Appropriate inhibitors are available, for example Sentinel, Fernox and Salamader. We also recommend a Magnetic & Non Magnetic Filtration system is fitted between the last radiator and the boiler.
- 4.1.6 Failure to carry out the above procedure will invalidate the guarantee!

4.2 HANDLING THE UNIT

- 4.2.1 The weight of this appliance exceeds that recommended for a one-man lift. It will therefore be necessary to gain assistance at times during the removal from its packaging and during installation procedure. Manoeuvring the boiler may include the use of a sack truck and involve lifting, pushing and pulling.
- 4.2.2 It should be noted that this appliance may contain sharp edges. Care **MUST** be taken when handling the appliance to prevent injury. We advise the engineer to wear suitable P.P.E.
- 4.2.3 Once the appliance has been fired beware that certain parts will be hot to the touch.
- 4.2.4 Do not install flues during rain, high winds or in severe weather conditions.
- 4.2.5 The manufacturers instructions supplied must not be taken as overriding any statutory requirements.

4.3 OPERATING THE APPLIANCE

- 4.3.1 This appliance is not intended for use by persons (including children) with reduced physical, sensory or mental capabilities, or lack of experience and knowledge, unless they have supervision or been given instruction concerning use of the appliance by a person responsible for their safety.
- 4.3.2 Children should be supervised to ensure they do not play with the appliance.

4.4 ELECTRICAL SUPPLY

- 4.4.1 Ensure the mains supply voltage, frequency, number of phases and power rating comply with details on the rating label.
- 4.4.2 All wiring must be in accordance with the appropriate standards. The equipment must be supplied with a double pole isolator switch and for new heating systems, and where practical replacement installations, the isolator shall be situated adjacent to the appliance.
- 4.4.3 Ensure safety regulations and practices are adhered to when installing and using this appliance.

4.5 GAS SUPPLY

- 4.3.1 It is the responsibility of the Gas Installer to size the gas installation pipework in accordance with BS 6891. Whilst the principle of the 1:1 gas valve ensures the QuanTec range is able to deliver it's full output at inlet pressures as low as 14mb, other gas appliances in the property may not be as tolerant. When operating pressures are found to be below the minimum meter outlet of 19mb these should be checked to ensure this is adequate for correct and safe operation.
- 4.3.2 Allowing for the acceptable pressure loss of 1mb across the installation pipework, it can be assumed that a minimum permitted operating pressure of 18mb will be delivered to the inlet of the appliance. (Reference BS 6400-1 Clause 6.2 Pressure Absorption).
- 4.3.3 The external gas cock could further reduce the operating pressure when measured at its test point. The pressure drop is relative to the heat input to the boiler (kW), see Figure 2.

IMPORTANT: Installation pipes must be fitted in accordance with BS 6891. In IE refer to IS.813.

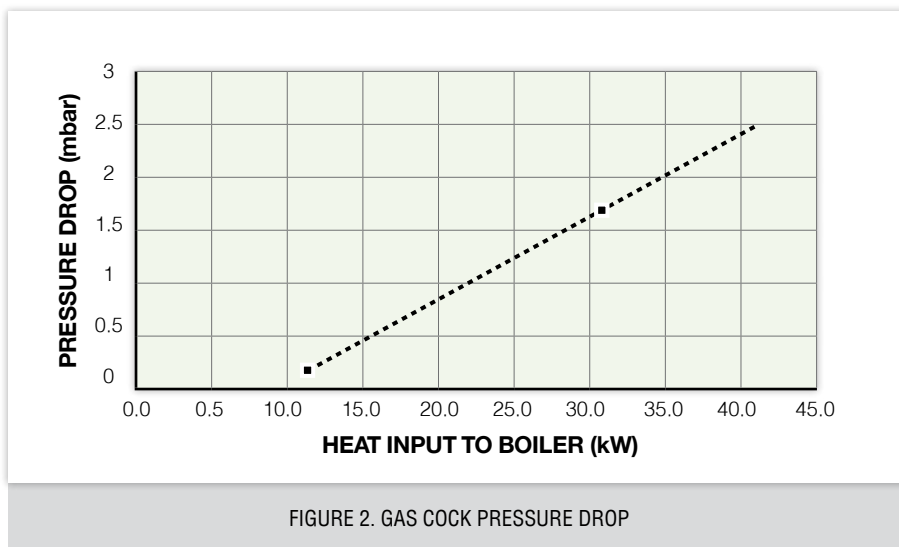

GAS LEAKS

**DO NOT OPERATE ANY ELECTRICAL SWITCHES, OR USE A NAKED FLAME
TURN OFF THE GAS SUPPLY. VENTILATE THE AREA BY OPENING DOORS AND
WINDOWS. CALL THE NATIONAL GAS EMERGENCY SERVICE ON**

0800 111999

5. TECHNICAL DATA

EU Regulations No. 811/2013 and No. 812/2013 supplementing Directive 2010/30/EU.

TABLE 1. ErP TECHNICAL DATA		HR28C		
PRODUCT DATA	SYMBOL	VALUE	UNIT	
Condensing boiler	-	Yes	-	
Low temperature boiler	-	No	-	
B11 Boiler	-	No	-	
Cogeneration space heater	-	No	-	
Combination Heater	-	Yes	-	
Rated heat output	P_{rated}	21	kW	
Seasonal space heating energy efficiency	η_s	94	%	
Energy efficiency class	-	A	-	
USEFUL HEAT OUTPUT				
At rated heat output and high temperature regime	P_4	21.4	kW	
At 30% of rated heat output and low temperature regime	P_1	7.3	kW	
USEFUL EFFICIENCY				
At rated heat output and high temperature regime	η_4	87.9	%	
At 30% of rated heat output and low temperature regime	η_1	98.8	%	
AUXILIARY ELECTRICITY CONSUMPTION				
At full load	$e_{l_{max}}$	0.068	kW	
At part load	$e_{l_{min}}$	0.048	kW	
In standby mode	P_{SB}	0.002	kW	
OTHER ITEMS				
Standby heat loss	P_{SB}	0.099	kW	
Ignition burner power consumption	P_{ign}	0	kW	
Sound power level indoors	L_{WA}	45	dB	
ADDITIONAL DATA FOR COMBINATION HEATERS				
Declared load profile		XL		
Daily electricity consumption	Q_{elec}	0.112	kWh	
Annual electricity consumption	AEC	24	kWh	
Daily fuel consumption	Q_{fuel}	21.03	kWh	
Annual fuel consumption	AFC	16.7	Gj	
Water heating energy efficiency	η_{wk}	91.4	%	
Water heating energy efficiency class	-	A	-	

1. High temperature regime means 60°C return temperature at heater inlet and 80°C feed temperature at heater output.
2. Low temperature means for condensing boiler 30°C, for low temperature boilers 37°C and for other heaters 50°C return temperature (at heater).



TABLE 2. TECHNICAL DATA	HR28C
Maximum weight lift	40kg
Gas supply	2H - G20 - 20mbar
Gas connection	15mm copper
Injector size	3.65mm
Domestic hot water flow and return	15mm copper
Heating flow and return	22mm copper
Safety valve discharge	15mm copper
Flue terminal diameter	100mm (4")
Average flue temperature-mass flow rate DHW	30°C 11g/s
Average flue temperature-mass flow rate CH	63°C 11g/s
Condense drain	21.5mm plastic overflow pipe
Maximum heating system water content using fitted expansion vessel	73lts
Electrical supply	230V ~ 50Hz
Electrical rating	100W
External fuse rating	3A
Expansion vessel capacity	8 litres
Expansion vessel initial charge pressure	1.0 bar
Heating system minimum pressure	0.5 bar
DHW maximum inlet pressure	6 bar
Minimum inlet pressure for appliance to operate	0.2 bar
Maximum flow rate at 35°C	12.3 l/m
Minimum domestic hot water flow rate	2.0 l/m
Maximum flow temperature	60°C
DHW specific rate	14.4 l/min
Water content CH	1.2 litres
Water content DHW	1.0 litres
Ball valves are fitted in water and gas connections	
For larger systems use an additional expansion vessel	

* Required for maximum flow rate. Boiler operates down to 2 l/min DHW delivery

** In areas of low water pressure the DHW restrictor can be removed

TABLE 3. PERFORMANCE DATA			MAXIMUM	MINIMUM
Burner CO ² (%)	case off		9.4	8.6
	case on		9.7	8.9
			± 0.5	
Maximum gas rate	m ³ /h		2.89	
PERFORMANCE DATA FOR CENTRAL HEATING				
CH input Q	Net	kW	21.6	4.5
	Gross	kW	23.87	4.99
Gas Consumption		m ³ /h		
CH Output	Non condensing	kW	21.1	4.41
	Condensing	kW	23.07	4.08
Seasonal Efficiency*	SEDBUK 2005		90.23	
	SEDBUK 2009		89.1	
NO _x Classification			CLASS 5 30mg/kWh	
Central Heating set point temperature range			20 - 82°C	
PERFORMANCE DATA FOR DOMESTIC HOT WATER				
DHW Input Q	NET	kW	28.6	
	GROSS	kW	31.09	
DHW output		kW	30.28	
DHW flow rate at 35°C temperature rise		l/m	12.3	
DHW specific rate		l/m	14.4	

* The value is used in the UK Government's Standard Assessment Procedure (SAP) for energy rating of dwellings. The test data from which it has been calculated have been certified by a notified body.

NOTE: Gas consumption is calculated using a calorific value of 38.7 MJ/m³ gross or 34.9 MJ/m³ nett. To obtain the gas consumption at a different calorific value:

- For l/s - divide the gross heat input (kW) by the gross C.V. of the gas (MJ/m³)
- For ft³/h - divide the gross heat input (Btu/h) by the gross C.V. of the gas (Btu/ft³)
- For m³/h - multiply l/s by 3.6

6. PREPARATION & POSITIONING

6.1 PREPARATION

6.1.1 ELECTRICAL CONNECTIONS: Make sure all the electrical cables are in place.

6.1.2 WATER CONNECTIONS: Important. A minimum length of 1 metre of copper pipe **MUST** be fitted to both flow and return connections from the boiler before connection to any plastic piping.

6.1.3 The central heating system should be in accordance with BS 6798 and for small bore and microbore systems, BS 5449.

6.1.4 It is important that the system is flushed thoroughly before the appliance is left to operate (as recommended in BS 7593) in order to maintain an efficiently operating heating system and in accordance with the Benchmark Guidance Notes on Water Treatment in Central Heating Systems. See paragraph 15.10.

6.1.5 GAS CONNECTIONS: Make sure the gas connections are in place.

6.1.6 Give consideration to the flue position. Plumbing will occur at the terminal so terminal positions where this could cause a nuisance should be avoided. See Figure 11.

6.1.7 Give consideration to the overall height. See section 7.

6.1.8 CONDENSE DRAIN: This drain must be connected to a drainage point on site. All pipework and fittings in the condensate drainage system **MUST** be made of plastic - no other materials may be used.

IMPORTANT: Any external runs must be in accordance with BS 6798. The drain outlet on the boiler is sized for standard 21.5mm (¾") overflow pipe.

- 6.1.9 BOILER CONTROL INTERLOCK:** Central heating system controls should be installed to ensure the boiler is switched off when there is no demand for heating, in compliance with Building Regulations.
- 6.1.10 THERMOSTATIC RADIATOR VALVES:** Central heating systems utilising thermostatic radiator valve controls in individual rooms, need one space heating temperature control over a living/dining area or hallway having a heating requirement of at least 10% of the minimum boiler heat output with a minimum 500W radiator, which should be achieved using a room thermostat. However, if the system employs thermostatic radiator valves on all radiators, or two port valves, then a bypass circuit must be fitted with an automatic bypass valve to ensure minimum flow is maintained.

6.2 POSITIONING

- 6.2.1** The boiler must be installed on a flat and vertical internal wall, capable of adequately supporting the weight of the boiler and any ancillary equipment.
- 6.2.2** The appliance is not suitable for external installation unless it is protected from the elements in a suitable enclosure. The enclosure must provide the required clearances for installation, servicing and maintenance as well as the correct level of ventilation. The selected position should allow for a suitable flue system to be installed.
- 6.2.3** The boiler may be installed in any room or internal space, although particular attention is drawn to the requirements of the current IEE (BS 7671) Wiring Regulations and the electrical provisions of the building regulations applicable in Scotland, with respect to the installation of the boiler in a room or internal space containing a bath or shower. For IE reference should be made to the current ETCl rules for electrical installations and I.S. 813.
- 6.2.4 TIMBER FRAME BUILDINGS:** When installed in a timber frame building guidance should be taken from the gas industry publication IGE/UP-7 (Guide for Gas Installations in Timber Frame Housing). BS 6798 gives details of the essential features for a compartment or cupboard where a gas appliance is to be installed. An existing cupboard may require modification.
- 6.2.5 BATHROOM INSTALLATIONS:** If the appliance is installed in a room containing a bath or shower it is important to locate the electrical switch in a position where it cannot be touched by anyone using the bath or shower. The current IEE Wiring Regulations (BS 7671) for England and the electrical provision of the Building Regulations for Scotland gives details. The appliance must be installed beyond Zone 2, as detailed in BS 7671. A compartment used to enclose the boiler should be designed and constructed specially for this purpose.
- 6.2.6 COMPARTMENT INSTALLATIONS:** An existing cupboard or compartment may be used, provided that it is modified for the purpose. In both cases, details of essential features of cupboard / compartment design, including airing cupboard installation, are to conform to the following:
- BS 6798 (No cupboard ventilation is required - see 'Air Supply' for details).
 - The position selected for installation MUST allow adequate space for servicing in front of the boiler.
 - For the minimum clearances required for safety and subsequent service, see the wall mounting template and section 7. In addition, sufficient space may be required to allow lifting access to the wall mounting bracket.
- 6.2.7 ROOM VENTILATION:** It is not necessary as the appliance draws it's combustion air from outside of the building. Cupboard or compartment ventilation is not necessary providing that the minimum clearances are maintained. However, reference should be made to BS 5440 Pt. 2.

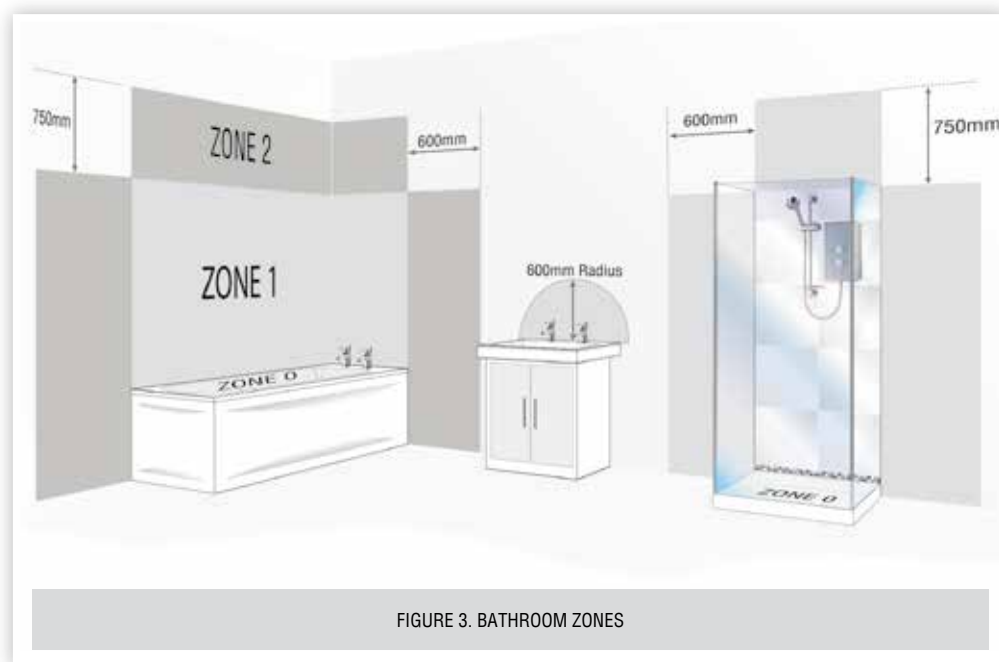

FIGURE 3. BATHROOM ZONES

7. DIMENSIONS & CLEARANCES

7.1 DIMENSIONS

7.1.1 It is recommended that where the appliance is located in a kitchen, or next to other combustible materials, a gap of 5mm be left on either side and where the flue run is through a void in kitchen units, again a minimum gap of 5mm should be left. For the purpose of servicing, it is also recommended that the appliance be located with a minimum gap of 200mm above any surface.

Note: A minimum 450mm dimension is a desired workable clearance for servicing.

7.1.2 The boiler connections are made on the boiler connection tails.

7.1.3 The minimum clearances must be maintained for operation and servicing.

7.1.4 Additional space will be required for installation, depending upon site conditions.

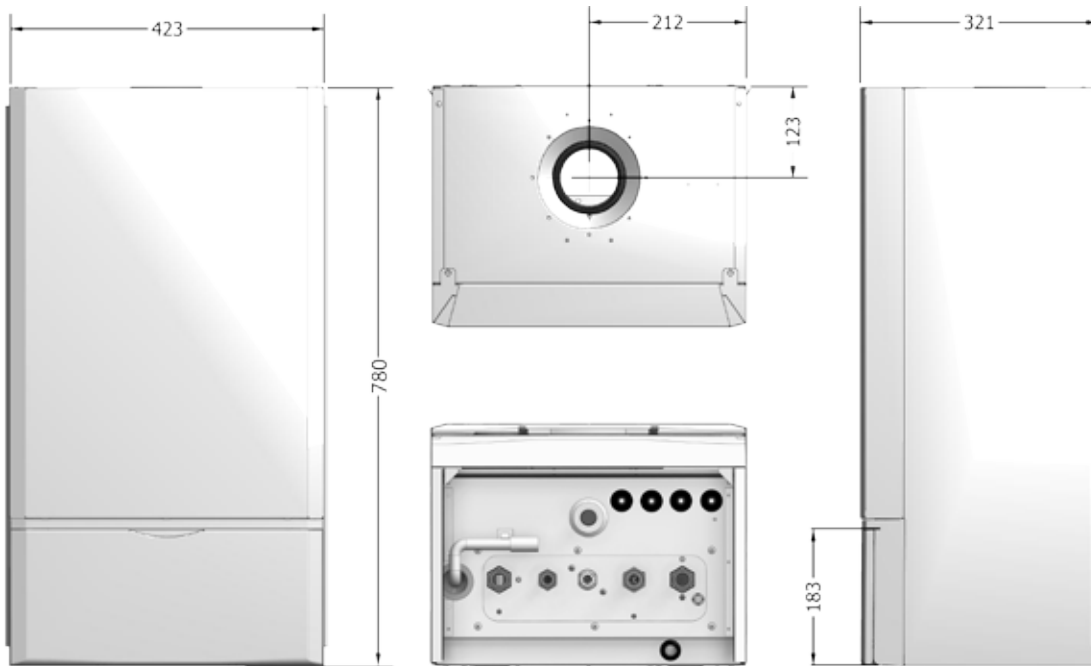

FIGURE 4. QUANTEC COMBI DIMENSIONS

7.2 CLEARANCES

7.2.1 Bottom clearance after installation can be reduced to 5mm. This must be obtained with an easily removable panel, to enable the consumer to view the system pressure gauge, and to provide the 200mm clearance required for servicing.

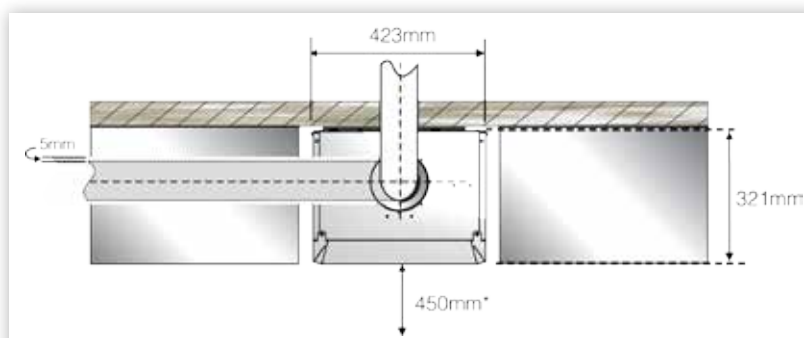

FIGURE 5. FLUE CLEARANCES KITCHEN LAYOUT - TOP VIEW

7.2.2 The minimum front clearance when built in to a cupboard is 5mm from the cupboard door but 450mm overall clearance is still required, with the cupboard door open, to allow for servicing.

TABLE 4. EXPANSION VESSEL REQUIREMENTS

		0.5	0.75	1.0	1.5
Vessel charge and initial system pressure bar	bar	0.5	0.75	1.0	1.5
Total water content of system using 8 liters (1.45 gals) capacity expansion vessel supplied with appliance	L	95	84	73	50
For system having a larger capacity multiply the total system capacity in liters by the factor to obtain the total minimum expansion vessel capacity required liters		0.0833	0.09	0.109	0.156

8. HEATING SYSTEM

- 8.1 The installation must comply with all relevant national and local regulations.
All components of the system must be suitable for a working pressure of 3 bar and temperature of 110°C. Extra care should be taken in making all connections so that the risk of leakage is minimised.
- NOTE:**
- The method of filling, refilling, topping up or flushing sealed primary hot water circuits from the mains via a temporary hose connection is only allowed if acceptable to the local water authority.
 - Antifreeze fluid, corrosion and scale inhibitor fluids suitable for use with boilers having stainless steel heat exchangers may be used in the central heating system.
- 8.2 **EXPANSION VESSEL:** The integral expansion vessel is pre-charged to a pressure of between 0.5 and 1.0 bar. This should be checked before the water system is filled. Table 3 show the water system volume that is acceptable for this vessel. If the system water volume is larger then an additional vessel must be fitted to the system. BS 5449 and BS 6798 gives further details regarding expansion vessel sizing and sealed systems. See Table 3.
- 8.3 **PRESSURE GAUGE:** The appliance has two components that monitor pressure. Firstly there is a mechanical pressure gauge on the CH flow outlet, this allows the heating system to be pre-plumbed and filled with a visual check on the pressure. The second is an electronic device used by the microprocessor control to monitor the system pressure and block the heat input, should there be a lack of pressure.
- 8.4 **PRESSURE RELIEF VALVE:** The pressure relief valve protects the system from over pressurisation. It is set to be fully open at 3 bar, however it will start to open at approximately 2.7 bar. It should not be used to flush the system. Using no less than 15mm diameter copper pipe, the discharge pipe must be extended to a safe place outside the building. The discharge position must be visible, not onto a public access area or above any window or entrance. The pipe must have a continuous fall and discharge to a safe place. It is possible that boiling water and/or steam could be discharged if the safety valve operates.
- 8.5 **FILLING LOOP:** The group set incorporates a filling loop that temporarily connects the DHW supply to the CH system. This is used to fill the CH system on installation and whenever the water pressure has been removed for system modifications, etc. The filling loop complies with the water supply (water fittings) regulations 1999 Section G24.1 and G24.2. After filling the system the hose should be disconnected and stored in a safe place for future use.
- 8.6 **PIPEWORK SIZING:** In order to keep the noise of the system to a minimum, the velocity of water should be kept below 1.5m/s and it should be noted that the appliance is designed to operate with a temperature differential of 20°C between flow and return. The maximum flow rates are 0.3 kg/s which, through a 22mm pipe, gives velocities of 1.00m/s. Therefore, the recommended minimum pipe size for the main carcass is 22mm.
- 8.7 **DOMESTIC HOT WATER SYSTEM REQUIREMENTS**
The DHW service must be in accordance with BS 5546 & BS 6700.
- 8.7.1 Domestic hot water circuits and their components, must be in accordance with the relevant standards and water supply regulations. Further guidance/recommendations can be found in building regulations G17 to 24 and R17 to 24.
- 8.7.2 The maximum domestic cold water supply pressure allowable for this appliance is 5 bar. If the supply pressure exceeds this, a pressure-reducing valve must be installed in the supply to the appliance.
- 8.7.3 If the water to the property is "hard", more than 200ppm of salts, then a scale inhibitor should be fitted. Such products are available from Salamander.
- NOTE:** The system must not be filled with 'softened' water. The cold water filling position should be before any softening product.
- 8.7.4 In areas of low mains water pressures the domestic hot water regulator may be removed from the DHW flow turbine cartridge. The boiler will require the flow rate to be set to obtain a temperature rise of 35°C at the tap furthest from the boiler.
- 8.7.5 The boilers are suitable for connection to most types of washing machine and dishwasher appliances.
- 8.7.6 When connecting to suitable showers, ensure that:
- The cold inlet to the boiler is fitted with an approved anti-vacuum or syphon non-return valve.
 - Hot and cold water supplies to the shower are of equal pressure.
- IMPORTANT:** Provision must be made to accommodate the expansion of DHW contained within the appliance. If the DHW inlet contains a back flow prevention device or non-return valve, e.g. A water meter, then a mini expansion vessel should be fitted between the device and the boiler in the cold inlet pipe.

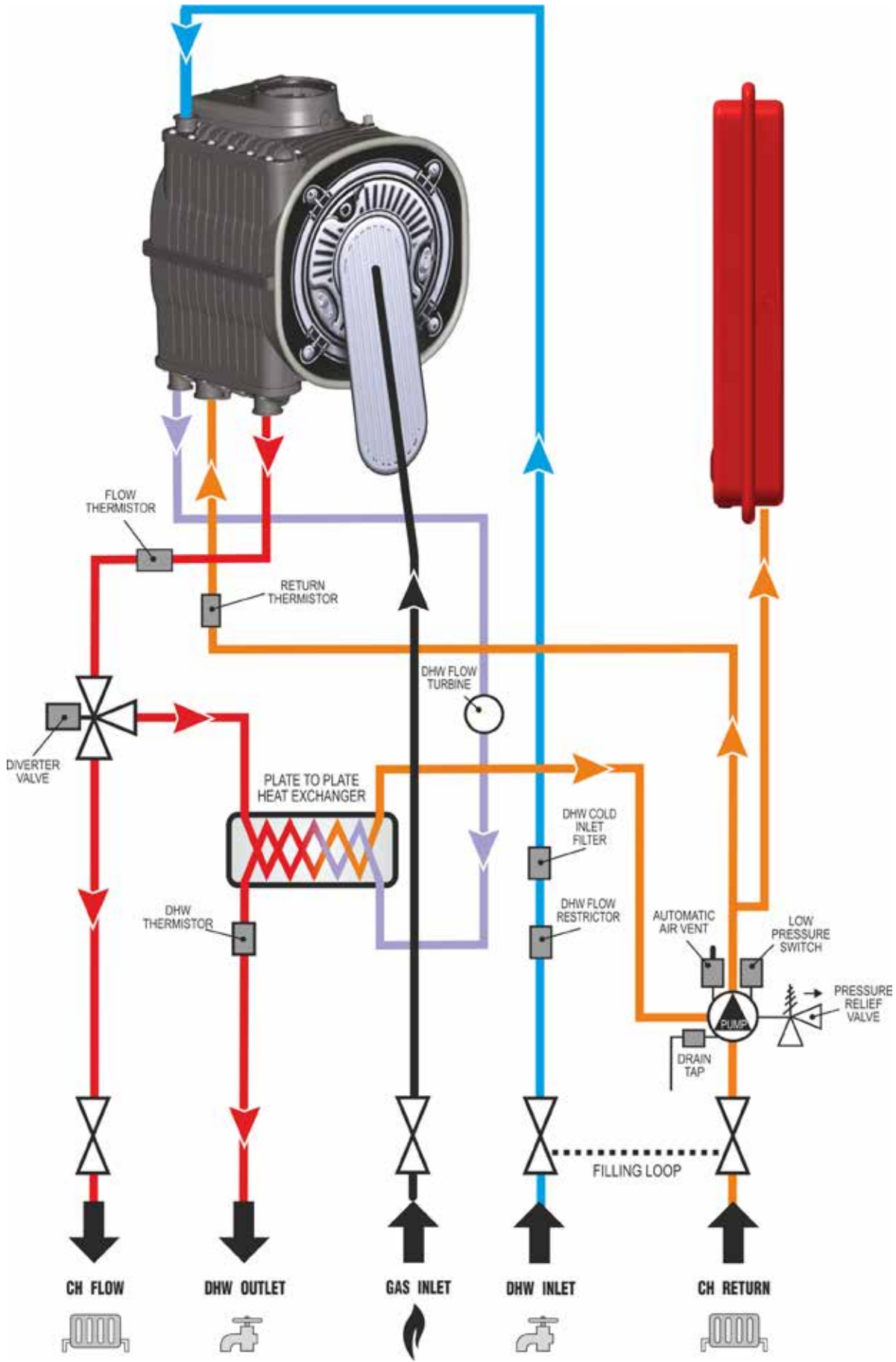

FIGURE 6. QUANTEC HR28C WATER FLOW SCHEMATIC

9. INSTALLATION INSTRUCTIONS

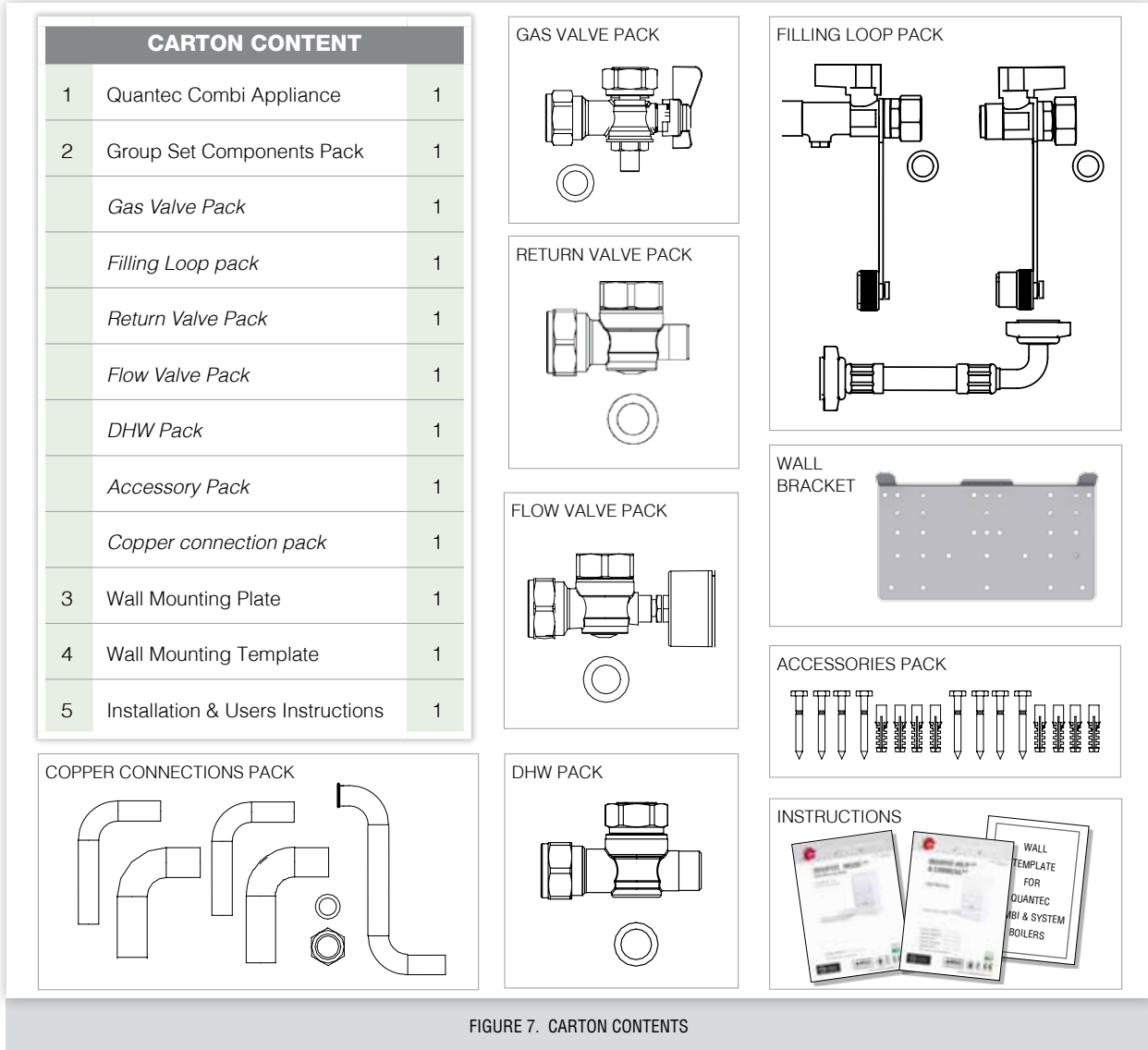

FIGURE 7. CARTON CONTENTS

9.1 WALL MOUNTING TEMPLATE

Use a plumb line to make sure the unit is square. Fix the template to the wall. Mark the positions of the flue and 4 fixing points.

9.1.1 Using a 105 mm core drill make the hole through the wall. Installations that are made from within the building only will require a 125 mm diameter hole in order to fit the flue system.

9.1.2 Using a 7mm bit, drill a minimum of 4 fixing holes for the wall plate. Insert the rawlplugs. Remove the template.

9.2 FIXING THE APPLIANCE

Caution: This appliance exceeds the recommended weight for a one-man lift as detailed in the Manual Handling Operations, 1992 Regulations.

9.2.1 It should be noted this appliance could contain sharp edges and care MUST be taken when handling.

9.2.2 Screw the wall bracket to the wall using the 4 screws provided.

9.2.3 Lift the appliance onto the fixing bracket and lower into position.

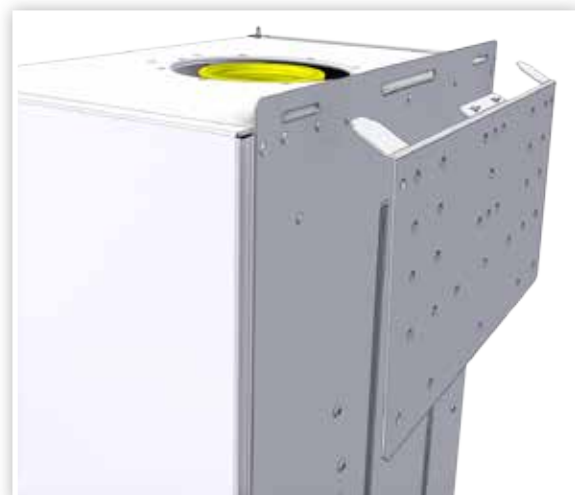

FIGURE 8. FIXING BRACKET

10. FLUE INSTRUCTIONS

10.1 The QuanTec HR28C Boiler is certified as a heating boiler with corresponding flue systems according to EU Directive 90/396/EEC on gas-fired devices. These installation instructions are covered by this certification and are referred to in the design approval test certificate.

10.2 The installation of the boiler and flue system must be in accordance with the Gas Safety (Installation and Use) Regulations 1998 and the Building Regulations. If no specific instructions are given, reference should be made to the relevant codes of practice.

THESE RELEVANT STANDARDS SHOULD BE FOLLOWED

BS 5440:1 Flues and ventilation for gas appliances of rated heating input not exceeding 70kW (net): Flues

BS 5440:2 Flues and ventilation for gas appliances of rated heating input not exceeding 70kW (net): Air Supply

Ensure all legislation, regulations and directives mentioned are observed.

10.3 The air/flue duct operates at very low temperatures therefore no clearance is necessary between the air duct and the adjacent services.

10.4 Ensure while installation work is being carried out that no debris such as swarf, filings or fragments of mortar remains in the air/flue duct.

10.5 FLUE CONFIGURATIONS







<p>STANDARD HORIZONTAL FLUE KIT</p>  <p>Standard flue kit comprising of: Turret Horizontal Terminal</p>	<p>OFFSET HORIZONTAL REAR FLUE</p> <p>Can be fitted to the left or the right.</p>  <p>Standard flue kit + 90° Elbow Required Extension Length</p>	<p>EXTENDED HORIZONTAL REAR FLUE</p> <p>Can be fitted to the left or the right.</p>  <p>Vertical Appliance Adaptor Horizontal Terminal 90° Elbow Required Extension Length</p>
<p>HORIZONTAL SIDE FLUE</p> <p>Can be fitted to the left or the right.</p> <p>Standard Flue Kit comprising of Turret Horizontal Terminal</p> 	<p>VERTICAL FLUE</p> <p>Vertical Appliance Adaptor Required Extension Lengths Vertical Terminal</p> 	<p>OFFSET VERTICAL FLUE</p> <p>Can be fitted to the left or the right.</p> <p>Turret Vertical Terminal 90° Elbow Required Extension Lengths</p> 
<p>FRONT SIDE FLUE</p> <p>Can be fitted to the left or the right.</p> <p>Standard Flue Kit + 90° Elbow Required Extension Length</p> 		

FIGURE 9. FLUE CONFIGURATIONS

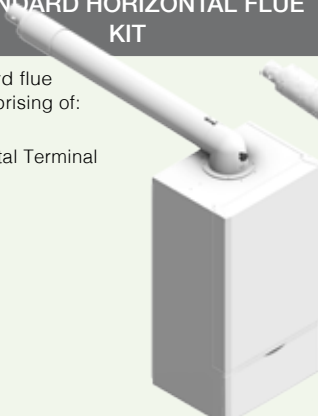
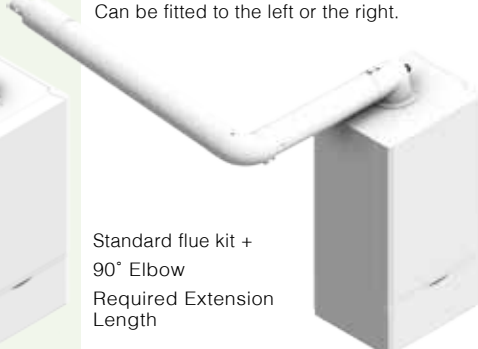

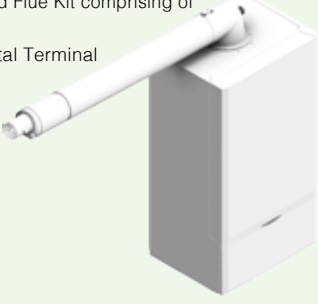
FIGURE 10. FLUE TERMINAL POSITIONS

TABLE 4	TERMINAL POSITION	MIN DISTANCE
A	Directly below an opening, air brick, opening window etc	300mm
B	Above an opening, air brick, opening window, etc.	300mm
C	Horizontally to an opening, air brick, opening window etc.	300mm
D	Below gutters, soil pipes or drain pipes.	75mm
E	Below eaves.	200mm
F	Below balconies.	200mm
G	From a vertical drain pipe or soil pipe.	150mm
H	From an internal or external corner. Greater than 450mm protrusion.	300mm
H	From an internal or external corner. Greater than 450mm protrusion.	300mm
I	Above ground, roof or balcony level.	300mm
J	From a surface facing the terminal.	600mm
K	From a terminal facing the terminal.	1,200mm
M	Vertically from a terminal on the same wall.	1,200mm
N	Horizontally from a terminal on the same wall.	300mm
Q	Above intersection with roof.	530mm
P	From a vertical structure on the roof	300mm
R	From the terminal to the boundary	300mm

10.6 TYPE OF FLUE SYSTEMS

- 10.6.1 The standard concentric flue system 60/100mm (100mm diameter).
- 10.6.2 A Flexible flue kit (FFK-5) 60/100mm (100mm diameter).
For further information contact the sales office at Johnson & Starley Ltd. Telephone 01604 762881.
- 10.6.3 The air/flue duct operates at very low temperatures therefore no clearance is necessary between the air duct and the adjacent services.

10.7 FLUE TERMINAL POSITIONS

10.7.1 The following information provides the general requirements for siting flue terminals. As part of the recommendation given in BS 1550 Part 1. For IE recommendations, see the current issue of I.S. 813 "Domestic Gas Installations." Also publication a "Guide for Gas Installations in Timber Framed Housing DM2" or consult your local gas region, MUST be consulted when installing the appliance into a timber-framed building.

NOTE: Due to the nature of the boiler, water vapour will discharge from the flue. This should be taken into account when siting the flue

- 10.7.2 Both the horizontal and vertical terminals must be positioned on the outside of the building and the free passage of air must be available at all times. It is not recommended to position the terminal close to projections especially under a balcony or near to a drainpipe.
- 10.7.3 Ensure that combustion products cannot enter the building where the heater is installed or near to any other building where doors or windows may be open.
- 10.7.4 Recommended terminal positions for both horizontal and vertical flues are shown. See Table 4. For flue components see Table 5.
- 10.7.5 Where the lowest part of the flue terminal is located less than 2 metres above the ground, a balcony or above a flat roof across which there is access, the terminal MUST be fitted with a guard (Part No: 1000-0019710) which is available from Johnson & Starley. The distance between the guard and the nearest part of the terminal must not be less than 50 mm.
- 10.7.6 The flue MUST NOT be installed under a car port.

10.8 PLUME TERMINAL OUTLETS

10.8.1 A flue duct outlet of an appliance should be at least 600mm from the boundary line when facing it and at least 300mm from the boundary line when running parallel to it. See Figure 11.

NOTE: When the flow of products is at an angle to the boundary, the 600mm dimension may be measured in the direction of the flow, as long as the terminal is not less than 300mm from the boundary.

10.8.2 It is recommended the terminals are not sited within 2m of an opening in an adjacent building or within 2m of the boundary facing the terminal if the plume is likely to cause a nuisance to a neighbour, e.g discharging over a walkway or patio.

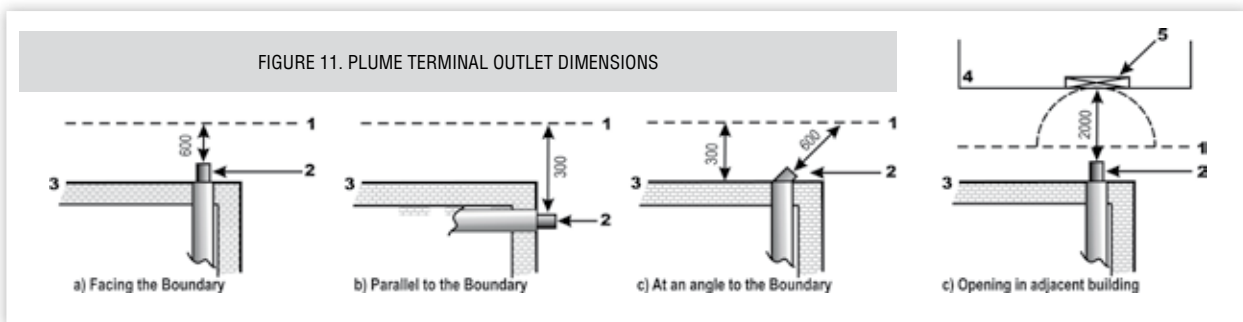

10.9 FLUE REQUIREMENTS & GENERAL INFORMATION

- 10.9.1 Horizontal and vertical concentric flues (60/100mm diameter) with balanced terminals may be installed on all the QuanTec appliances.
- 10.9.2 If an extended horizontal flue is being used it must have a continuous fall back towards the appliance of 3° (52mm) per meter. This ensures that condensate runs back into the appliance from the flue system for safe discharge via the condensate waste pipe. Reference should be made to Table 5 for relevant part numbers.
- 10.9.3 The maximum length of flue permissible is 12 meters including terminal
- 10.9.4 The minimum vertical flue length is 1.25m from the top of the appliance case to the top of the terminal.
- 10.9.5 Longer flues may be fitted, however the input of the appliance will be reduced accordingly.
- 10.9.6 Elbows may be fitted within the flue system with a corresponding reduction in overall flue.
- 10.9.7 Guidelines for the maximum flue length are as follows.

HORIZONTAL FLUE			VERTICAL FLUE	
TURRET	90° ELBOW	STRAIGHT 1m FLUE	90° ELBOW	STRAIGHT 1m FLUE
1	-	10	-	10
1	1	8	1	8
1	2	6	2	6
1	3	4	3	4
When using 45° elbows: 2 x 45° elbow = 1 x 90° elbow				

10.10 CONVENTIONAL 60/100mm FLUE ACCESSORY PARTS No's

TABLE 5.	DESCRIPTION	COLOUR	QTY	APPLICATION	PART No.
1	60/100 Standard Horizontal Flue Kit	White	1	Horizontal	1000-0020070
2	Turret	White	1	Horizontal	1000-0020020
3	800mm Horizontal Terminal	White	1	Horizontal	1000-0019830
4	Vertical Appliance Adaptor	White	1	Vertical	1000-0018990
5	45° Elbow	White	1	Horizontal & Vertical	1000-0018980
6	90° Elbow	White	1	Horizontal & Vertical	1000-0018970
7	250mm Straight Extension	White	1	Horizontal & Vertical	1000-0018960
8	500mm Straight Extension	White	1	Horizontal & Vertical	1000-0018950
9	1000mm Straight Extension	White	1	Horizontal & Vertical	1000-0018940
10	2000mm Straight Extension	White	w	Horizontal & Vertical	1000-00025570
11	Flat Roof Weather Collar		1	Vertical	1000-0020060
12	Pitched Roof Collar	Black	1	Vertical	1000-0020030
13	Ridge Terminal	Terracotta	1	Horizontal & Vertical	1000-0021030
14	Wall Fixing Bracket 100mm		1	Horizontal & Vertical	1000-0018930
15	1140mm Vertical Terminal	White/Black	1	Vertical	1000-0020740
16	Plume Management Kit	Black	1	Horizontal & Vertical	1000-0020730
17	1000mm Extension Flue 60mm	Black	1	Horizontal & Vertical	1000-0020740
18	90° Elbow 60mm Ø	Black	1	Horizontal & Vertical	1000-0020680
19	45° Elbow 60mm Ø	Black	2	Horizontal & Vertical	1000-0020670
20	Wall Fixing Bracket 60mm		1	Horizontal & Vertical	1000-0020770
21	Flexible Flue Kit 60/100mm	Black	1	Flexible	FFK5
22	Flexible Black Outer Pipe	Black	1	Flexible	1000-0023410
23	Flexible Grey Inner Pipe	Grey	1	Flexible	1000-0023420
24	Outer Rigid to Flex Adapter	Grey	1	Flexible	1000-0023430
25	Inner Rigid to Flex Connector	Grey	1	Flexible	1000-0023440
26	Outer Flex to Rigid Adapter	Grey	1	Flexible	1000-0023450
27	Inner Flex to Rigid Connector	Grey	1	Flexible	1000-0023460
28	Outer Seal Pipe Rings		2	Flexible	1000-0023470
29	Inner Seal Pipe Rings		2	Flexible	1000-0023480
30	Centralising Spacer Ring		1	Flexible	1000-0023490
31	Flue Support Kit		1	Flexible	1000-0023500
32	Draw Cone & Rope		1	Flexible	1000-0023510
33	Chimney Terminal Kit 60/100mm	Black	1	Vertical	CTK-60/100
34	Skyline Terminal & Outer Flue Cowl	Black	1	Vertical	1000-0023990
35	Locking Ring	Grey	1	Vertical	1000-0026610
36	Flashing Ring	Grey	1	Vertical	1000-0026660
37	Chimney Cover Plate		1	Vertical	1000-0026600

10.11 OPTIONAL ROOF OUTLETS

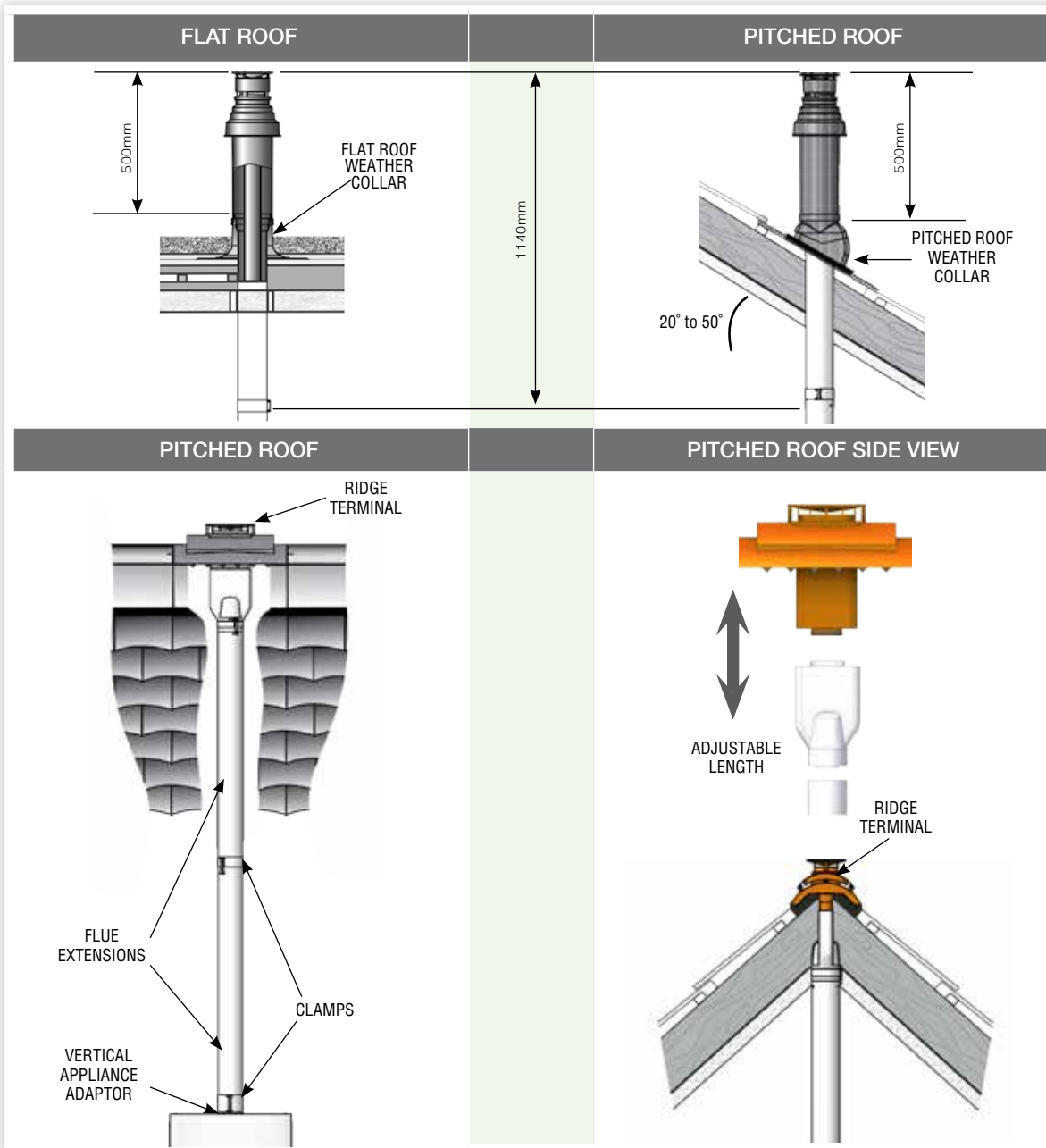

FIGURE 12. OPTIONAL ROOF OUTLETS

10.12 THE STANDARD HORIZONTAL FLUE SYSTEMS

The standard horizontal flue kit comprises of:

ITEM	DESCRIPTION	QTY
1	Turret	1
2	Appliance Seal	1
3	60/80 Adaptor	1
4	EPDM Outside Wall Cover Plate	1
5	Inside Wall Cover Plate	1
6	100mm Diameter Clamp	1
7	800mm Horizontal Terminal	1

The appliance comes with a wall template.
(Label Ref: 1000-2217950-3)

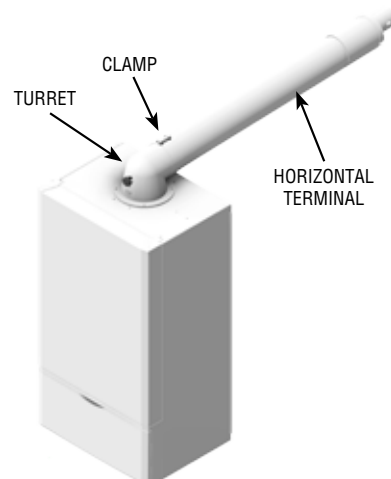

FIGURE 13. STANDARD HORIZONTAL FLUE

10.13 INSTALLATION OF THE STANDARD FLUE SYSTEMS

IMPORTANT NOTE: Before carrying out this procedure ensure seal has not been dislodged from top of the boiler.

- 10.13.1 Using the template supplied with the boiler, determine the position of the flue.
- 10.13.2 If access is available from outside drill a 105mm diameter hole. If no access is available refer to section 2.
- 10.13.3 Mount the wall bracket and the boiler on the wall as detailed in paragraph 9.1.
- 10.13.4 Fit the appliance seal to the underside of the turret and fix the turret to the top of the boiler using the 4 screws supplied, ensuring that the heat exchanger flue seal is in place.
- 10.13.5 Take a measurement from the outside of the wall to the edge of the turret dimension "X" Figure 14.

- 10.13.6 Mark this dimension onto the horizontal terminal as shown in Figure 15.
- 10.13.7 Cut the flue to the desired length. Make sure the ends are square and free from burrs and the inner plastic flue pipe is chamfered.

NOTE: To ease the assembly of the flue components, apply suitable silicone lubricant to the male plastic end. (Any other type of lubricant may corrode the gasket.)

- 10.13.8 Place flue clamp over turret rim.
- 10.13.9 From the outside of the building, push the terminal through the wall and locate the male plastic end of the terminal into the female end of the turret.
- 10.13.10 Place clamp equally over the turret and terminal ends and tighten the 2 screws.
- 10.13.11 Fit the rubber-finishing ring over the outside of the flue, pushing it flush to the wall. The rib on the inside of the ring will locate in-between the locating pips on the end of the terminal.

10.14 NO OUTSIDE ACCESS

- 10.14.1 If no access is available from outside the building drill a 125mm diameter hole.
- 10.14.2 Mount the wall bracket and the boiler on the wall as detailed para 9.1.
- 10.14.3.
 - a. For a rear flue measure the wall thickness and add; 40mm for a standard rear flue 90mm for a rear flue if the standoff bracket is used.
 - b. For a side flue measure the distance from the outside wall to the side of the boiler and add; Length shown in Figure 16. This dimension is known as dimension "X".
- 10.14.4 Mark this dimension on to the turret as in Figure 14.
- 10.14.5 Cut the flue to the desired length. Make sure the ends are square and free from burrs and the inner plastic flue pipe is chamfered.

NOTE: To ease the assembly of the flue components, apply suitable silicone lubricant to the male plastic end. (Any other type of lubricant may corrode the gasket.)

- 10.14.6 Fit the rubber-finishing ring over the outside of the flue. The rib on the inside of the ring will locate in-between the locating pips on the end of the terminal.
- 10.14.7 Push the terminal through the hole in the wall.
- 10.14.8 Fit the appliance seal to the underside of the turret and fix the turret to the top of the boiler using the 4 screws supplied, ensuring that the flue seal and 80/60 reducer is in place.
- 10.14.9 Place flue clamp over turret rim.
- 10.14.10 Pull back the terminal through the wall locating the male plastic end of the terminal into the female end of the turret.
- 10.14.11 Place the clamp equally over the turret and terminal and tighten the 2 screws.

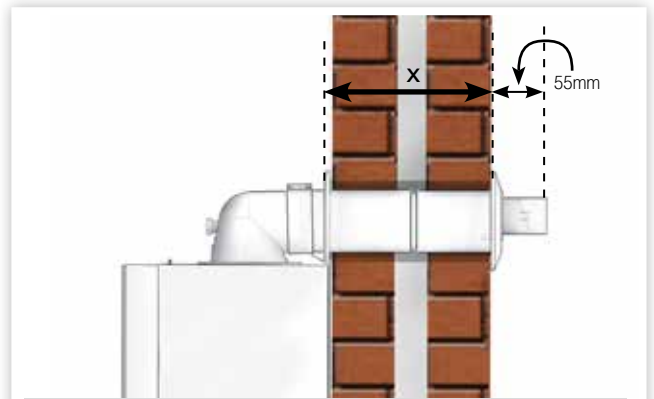

FIGURE 14. FLUE THROUGH THE WALL

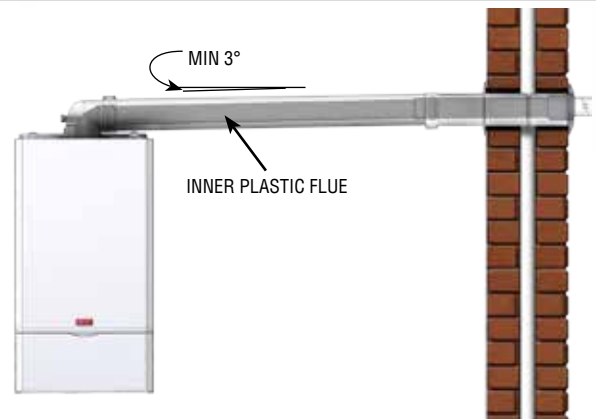

FIGURE 14b. EXTENDED FLUE THROUGH THE WALL

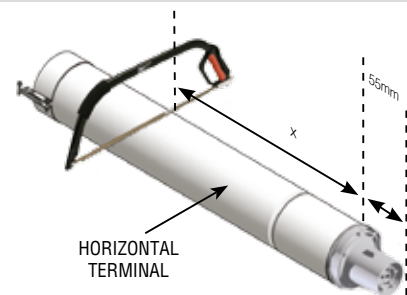

FIGURE 15. MEASURING THE FLUE

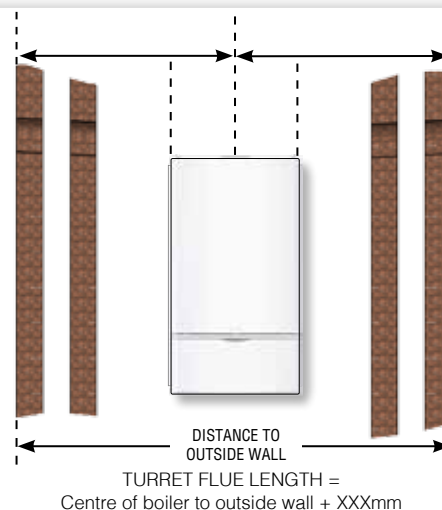

FIGURE 16. MEASURING WALL DISTANCES

11. CONDENSATE DRAIN

11.1 Where a new or replacement boiler is being installed, access to an internal "gravity discharge" termination should be one of the main factors considered when determining potential boiler locations, the condensate drainage pipe should be terminated as recommended.

11.2 Internal condensate drainage pipework must be a minimum of 19mm ID (typically 22mm OD) plastic pipe and this should "fall" at least 45mm per metre away from the boiler, taking the shortest practicable route to the termination point.

11.3 In order to minimise the risk of freezing during prolonged very cold spells, the condensate drainage pipe should be terminated at a suitable internal foul water discharge point using either:-

- an internal soil and vent stack
- an internal kitchen or bathroom waste pipe, washing machine waste pipe etc. A suitable permanent connection to the foul waste pipe should be used. Figures 18 to 20 show appropriate connection methods.

11.4 **USE OF A CONDENSATE PUMP (TO AN INTERNAL TERMINATION):** Condensate can be removed using a proprietary condensate pump, of a specification recommended by the boiler or pump manufacturer.

11.5 **EXTERNAL TERMINATION:** The use of an externally-run condensate drainage pipe, terminating at a suitable foul water discharge point or purpose-designed soakaway, may be also be considered; however if this termination method is chosen then the following measures should be adopted - The pipe should be run internally as far as possible before going externally and the pipe diameter should be increased to a minimum of 30mm ID (typically 32mm OD) before it passes through the wall. The external run should be kept as short as possible, taking the most direct and "most vertical" route possible to the discharge point, with no horizontal sections in which condensate might collect. The external pipe should be insulated using suitable waterproof and weatherproof insulation ("Class O" pipe insulation is suitable for this purpose) .

11.6 The use of fittings, elbows etc should be kept to a minimum and any internal "burrs" on cut pipework should be removed so that the internal pipe section is as smooth as possible.

11.7 The customer/householder should be advised that even with the above measures this type of installation could freeze, and that if this were to occur then boiler shutdown could result, requiring remedial action - possibly involving a chargeable engineer call-out.

11.8 Where there are likely to be extremes of temperature or wind-chill, the use of a proprietary trace-heating system for external condensate drainage pipework, incorporating an external frost thermostat, should therefore be considered. If such a system is used then the installation instructions of the trace heating manufacturer and any specific recommendations regarding pipe diameter, insulation, etc. should be followed. All other relevant guidance on condensate drainage pipe installation should also be followed.

11.9 If an external soil/vent stack is used as the external termination then the connection method shown in Figure x should be used, together with the measures on insulation etc. as described above and shown in the diagram.

11.10 Where the condensate drain pipe terminates in a purpose-designed soakaway (see BS 6798 or boiler installation manual for soakaway design requirements) any above-ground section of condensate drainage pipe should be run and insulated as described above. Figure 7 shows a suitable connection method. (see Figure 20).

11.11 **UNHEATED INTERNAL AREAS:** Internal condensate drainage pipes run in unheated areas such as lofts, basements and garages should be treated as external pipe.

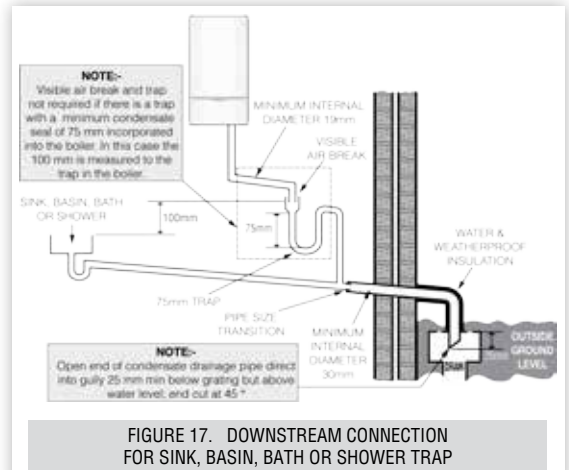

FIGURE 17. DOWNSTREAM CONNECTION FOR SINK, BASIN, BATH OR SHOWER TRAP

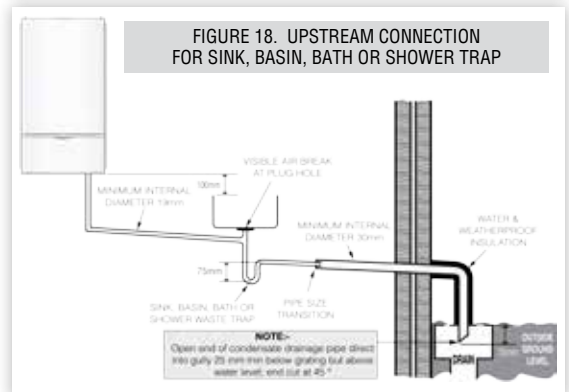

FIGURE 18. UPSTREAM CONNECTION FOR SINK, BASIN, BATH OR SHOWER TRAP

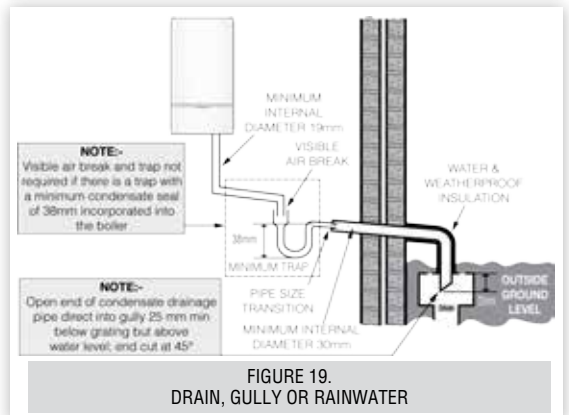

FIGURE 19. DRAIN, GULLY OR RAINWATER

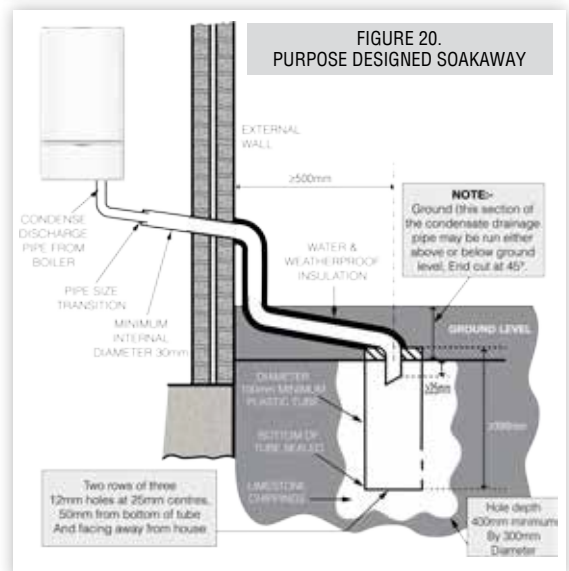

FIGURE 20. PURPOSE DESIGNED SOAKAWAY

12. ELECTRICAL

WARNING: This appliance must be earthed.

12.1 DROP DOWN CONTROL PANEL: See paragraph 17.5.

12.2 ELECTRICAL CONNECTIONS

- 12.2.1 A mains supply of 230Vac ~ 50 Hz is required.
- 12.2.2 The fuse rating should be 3A. All external controls and wiring must be suitable for mains voltage.
- 12.2.3 Wiring external to the boiler MUST be in accordance with the current I.E.E. (BS 7671) Wiring Regulations and any local regulations.
- 12.2.4 Wiring should be 3 core PVC insulated cable, not less than 0.75mm² (24 x 0.2mm), and to BS 6500. For IE reference should be made to the current ETCI rules for electrical installations.
- 12.2.5 Connection must be made in a way that allows complete isolation of the electrical supply such as a double pole switch having a 3mm (1/8") contact separation in both poles. The means of isolation must be accessible to the user after installation.

12.3 INTERNAL WIRING

- 12.3.1 The boiler comes pre-fitted with 1.8m of mains cable.
- 12.3.2 This must be connected to a permanent live supply and NOT switched by thermostats/programmers.
- 12.3.3 The boiler comes pre-fitted with a link wire between the room thermostat/Timer connections on the terminal strip. This creates a permanent call for heat and must be removed when adding a room thermostat/programmer.

12.4 TO ADD THERMOSTAT/PROGRAMMER

- 12.4.1 Isolate the mains supply to the boiler.
- 12.4.2 Remove the front panel. See paragraph 17.5.
- 12.4.3 Swing the control box down into the servicing position. See Figure 31.
- 12.4.4 Route incoming cables through the grommets in bottom panel (note, grommets are 'blind' and will require puncturing) and secure using clamps and screws provided in hardware pack.
- 12.4.5 Connect wires to terminal block.
- 12.4.6 Swing the control box back up into the operating condition and re-fit the front panel ensuring a good seal is made.

12.5 THERMOSTATS & TIMER KITS: Telephone Johnson & Starley on 01604 762881 for details.

12.5.1 MECHANICAL TIMER (24 HR) KIT: 24 hour mechanical CH timer fits into the control box of the boiler. This can be fitted in conjunction with a room thermostat.

12.5.2 ELECTRONIC TIMER (7 DAY) KIT: 7 day electronic CH timer fits into the control box of the boiler. This can be fitted in conjunction with a room thermostat. Features English language installation help messages.

12.5.3 ROOM THERMOSTAT (NO TIMER)

- a. Remove link wire between Room stat/timer terminals.
- b. Connect room stat across terminals as shown in diagram. See Figure 22.

12.5.4 ROOM THERMOSTAT with TIMER

- a. Remove link wire between Room stat/timer terminals.
- b. Connect room stat and programmer in series as shown in diagram. See Figure 22.

12.5.5 FROST THERMOSTAT

If parts of the system are vulnerable to freezing or the programmer is likely to be left off during cold weather, a frost stat should be fitted in conjunction with a pipe thermostat.

- a. Position the frost thermostat in a suitable position, i.e. area vulnerable to freezing.
- b. Connect frost stat in series with room stat as shown in diagram. See Figure 22.

12.6 OPTIONAL SYSTEM CONTROL

Open therm protocol controls are available for outside temperature compensation and room temperature sensing and can be used to improve the heating system control. They must be connected to the correct terminals as described in their own instructions. A room thermostat MUST NOT be used with these controls.

12.7 ELECTRICAL TESTING

Carry out electrical checks:

- Earth continuity and short circuit of cables
- Polarity of the mains supply
- Insulation resistance to earth

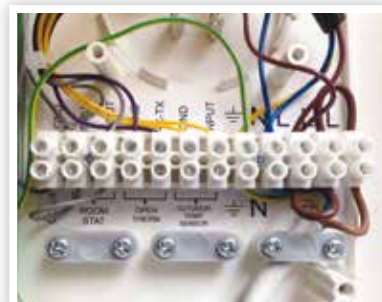

FIGURE 21.
ELECTRICAL CONNECTIONS

13. WIRING DIAGRAM

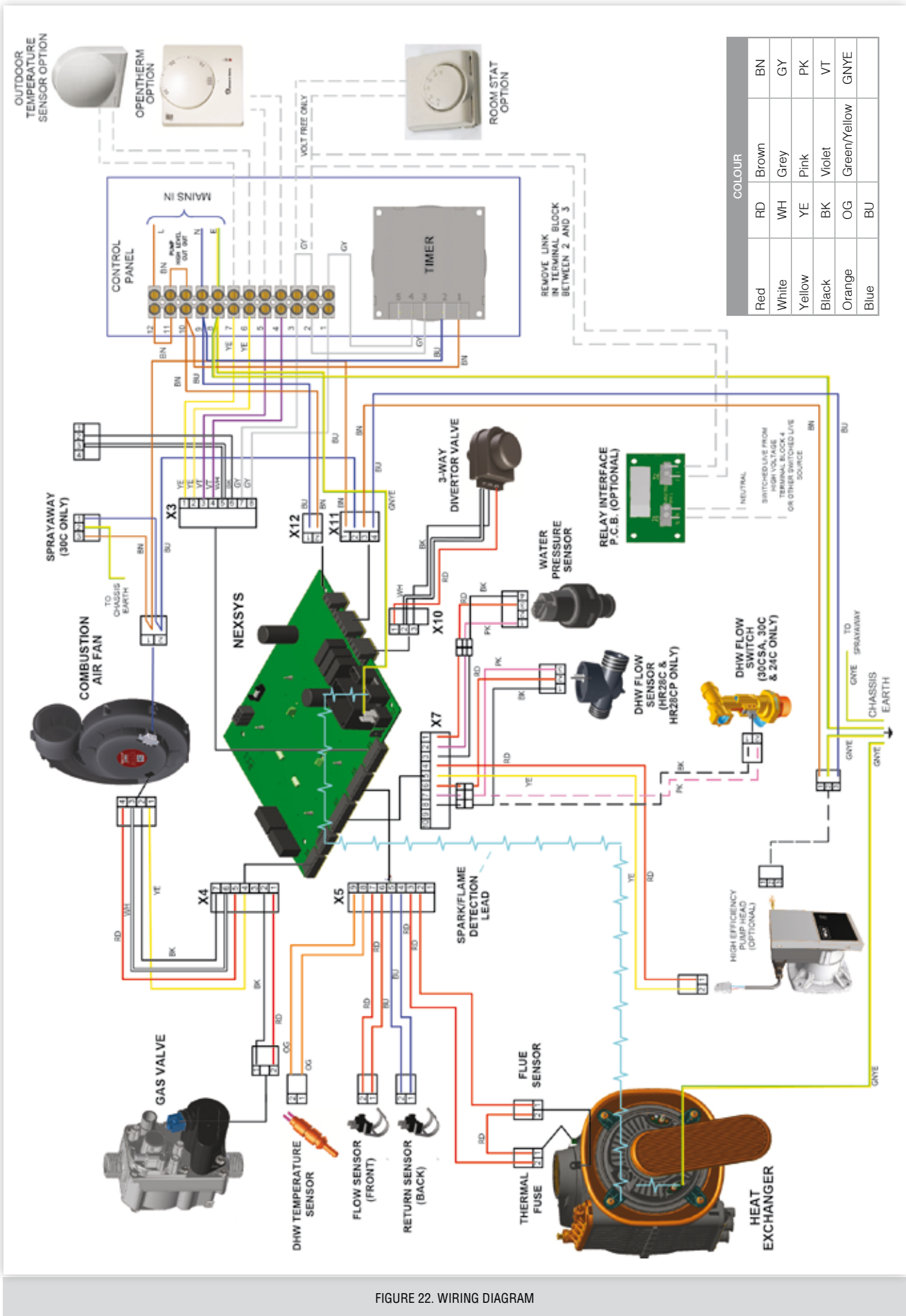

FIGURE 22. WIRING DIAGRAM

14. CONNECTIONS & FILLING

NOTES. Ensure all boss blanking plugs are removed before connecting hardware. Each valve must be fitted to the correct boss as shown. See Figure 25.

Ensure each union is fitted with fibre seals provided. On the DHW inlet use the filter washer provided. DO NOT use a fibre seal.

Do not subject any of the isolating valves to heat as the seals may be damaged.

14.1 WATER CONNECTIONS CH

14.1.1 Connect the CH flow service valve (black handle) and copper tail provided in the hardware pack to the threaded boss connection provided at the lower rear of the boiler.

14.1.2 Connect the CH return valve (black handle) and copper tail.

14.2 GAS CONNECTION

IMPORTANT. The gas service cock is sealed with a non-metallic blue fibre washer, which must not be overheated when making capillary connections. See Figure 23 for details of the position of the gas connection.

14.2.1 For additional information of the Gas Supply see paragraph 4.3.

14.3 CONDENSATE DRAIN

14.3.1 The condensate drain tube is secured by a cable tie when packed. This cable tie needs to be cut and removed before connecting to the condensate drain hose. Remove the bung from the pipe.

14.3.2 Connect the condensate drain tube.

14.4 PRESSURE RELIEF VALVE DRAIN

14.4.1 The drain comprises of a 15mm diameter stub pipe. See Figure 23.

14.4.2 The discharge pipe should be positioned so that the discharge of water or steam cannot create a hazard to the occupants of the premises or damage the electrical components and wiring.

14.5 FILLING THE BOILER

IMPORTANT. When filling, there may be a slight water leak from the air vent therefore electrical connections must be protected.

14.5.1 Ensure Filling Loop is connected.

14.5.2 Ensure the cap on auto air vent is open. (In the up position)

14.5.3 Check all isolation handles on all water connections are in the open position.

14.5.4 Open the black handle (G) on the filling loop, then slowly open the black handle (F) until the pressure gauge reads between 1 to 1.5 bar. When reached closed the isolation valves.

14.5.5 Disconnect the left hand filling loop, retain the top hat washer and using the blanking caps, cap off the connection and the end of the filling loop.

14.5.6 Connect extended blanking cap and top hat washer to filling loop pipe.

NOTE: Fully open all DHW taps and ensure water is flowing freely.

15. COMMISSIONING

15.1 CHECK GAS INSTALLATION

15.1.1 The whole of the gas installation, including the meter, should be inspected and tested for tightness and purged in accordance with the recommendations of BS. 6891. In IE refer to IS.813.

15.1.2 Purge air from the gas installation by the approved methods only.

PLEASE NOTE: The combustion for this appliance has been checked, adjusted and preset at the factory for operation on the gas type defined on the appliance data plate. A flue Gas Analyser measurement is a recommendation from April 2013 and a requirement from April 2014. Do not adjust the air/gas ratio valve.

15.1.3 Having checked the boiler has been installed in accordance with these instructions. The integrity of the flue system and the flue seals, as described in the Flue Installation section. Proceed to put the boiler into operation as follows:

15.2 AIR PURGE FUNCTION

15.2.1 During this function, heat demand is switched off and fan will run at maximum for 120 seconds.

15.2.2 Also at the same time, the supply pump will be switched on for 5 seconds and off for 5 seconds continuously.

15.2.3 Diverting 3 way valve will move to the CH position for the first 30 seconds and then to the DHW position. This will be repeated.

15.2.4 This way, air bubbles dissipate and normal operation of the supply pump is secured.

15.2.5 Function can be skipped by pressing the K4 button. This function can be activated in the following conditions:

- If the controller is plugged in to the Mains for the first time.
- After a manual reset to reset the lockout fault E03. High limit temperature protection.
- When the central heating water pressure is built up to the normal level after the fault F37 or fault F40.

15.2.6 If there is no heat demand afterwards, the controller will switch to standby mode.



FIGURE 23.
GAS PRESSURE
TEST POINT

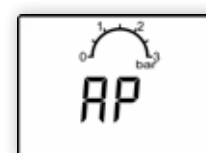
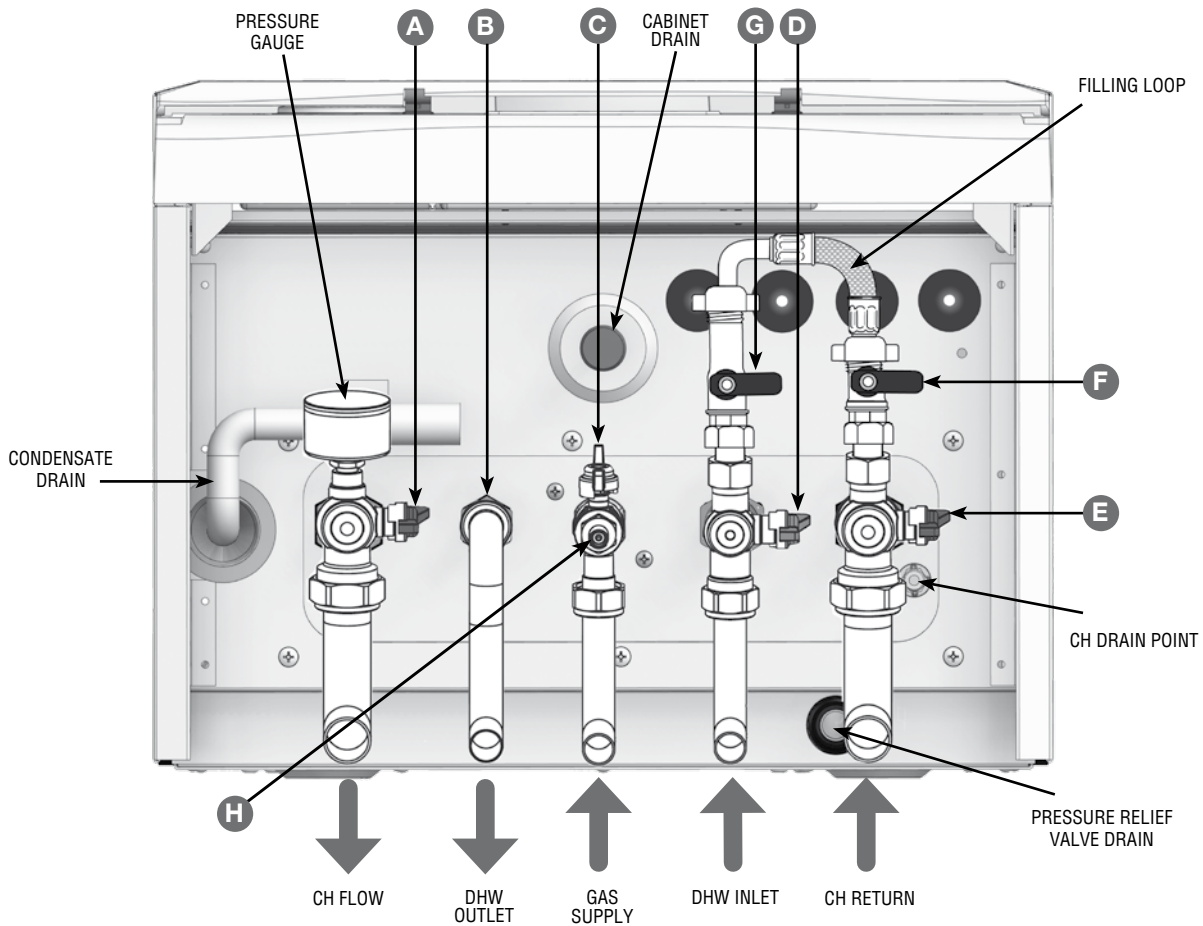

FIGURE 24.
LED READ OUT



ITEM	DESCRIPTION	ITEM	DESCRIPTION
A	CH - Central heating flow. Black handle	E	CH - Central heating return. Black handle
B	DHW - Domestic hot water outlet	F	Filling loop isolation valves. Black handle
C	Gas Valve. Yellow handle	G	
D	DHW - Domestic hot water inlet. Blue handle	H	Gas valve test point

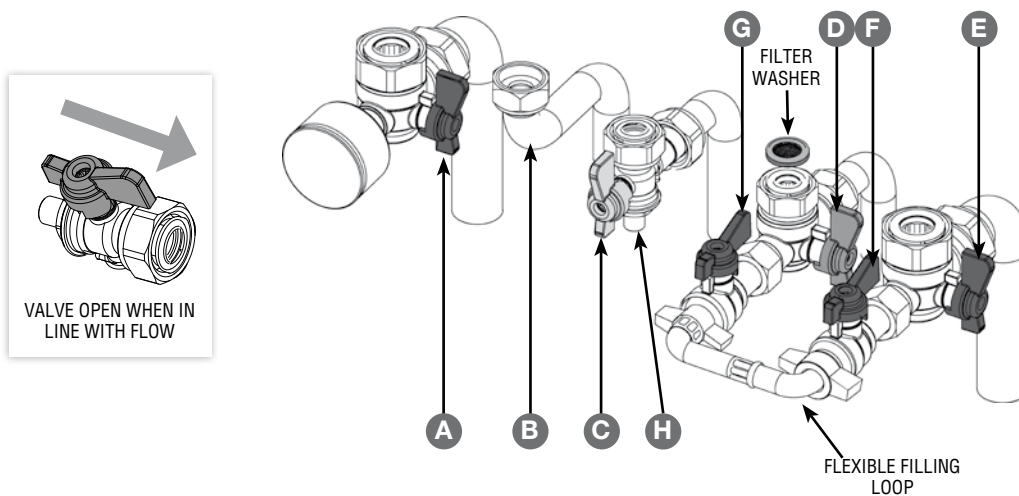
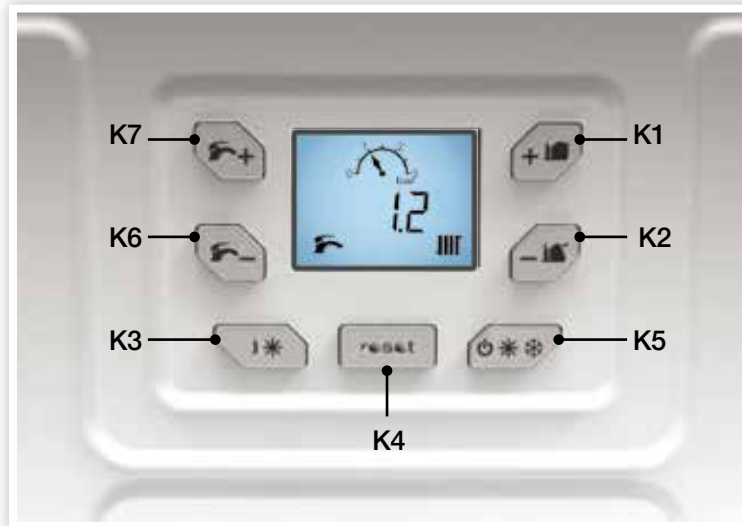

FIGURE 25. VALVES, TAIL PIPES & CONNECTIONS

15.3 RESET PROCEDURE

To reset boiler press the reset button 'K4' twice.

Item	Description
K1	CH - Central Heating +
K2	CH - Central Heating -
K3	Installer information
K4	Reset
K5	Summer/Winter mode
K6	DHW - Domestic Hot Water -
K7	DHW - Domestic Hot Water +



15.4 TEST MODE

- 15.4.1 To put the unit into test mode, press and hold K1 & K2 for 5 seconds.
- 15.4.2 Using K1 and K2 to select the required setting.
- 15.4.3 To reset press "K4" button twice.



FIGURE 26. QUANTEC COMBI LCD DISPLAY

15.5 INITIAL LIGHTING

- 15.5.1 Check that the system has been filled and the boiler is not air-locked. Ensure the automatic air vent cap is open.

NOTE: It is important the burner is not operated before the system is fully vented of air.

IMPORTANT: The gas input to the burner is regulated by the gas valve according to the air flow produced by the fan. It is not user-adjustable. Any interference to sealed settings on the gas valve will adversely affect operation and render our warranty void.

- 15.5.2 Refit the boiler front panel. See paragraph 17.5.
- 15.5.3 Check that the drain cock is closed and that the CH and DHW isolating valves (A, E, and D) are OPEN.
- 15.5.4 Check that the electrical supply is OFF.
- 15.5.5 Check that the gas service cock is OPEN. (C)
- 15.5.6 Slacken the screw in the inlet pressure test point (H) and connect a gas pressure gauge via a flexible tube.
- 15.5.7 Switch the electricity supply ON and check all external controls are OFF. The boiler will select 'self purge'

15.6 CENTRAL HEATING

- 15.6.1 Select the winter mode.
- 15.6.2 Set the CH temperature to maximum and switch on thermostat. The boiler control should now go through its ignition sequence until the burner is established.
- 15.6.3 If the boiler does not light, after 5 attempts the error code E-01 will be displayed.
- 15.6.4 Reset the boiler (see paragraph 15.3). The boiler will repeat its ignition sequence. If reset occurs 5 times within 15 minutes then F-15 will be shown. If power is removed this will be reset.
- 15.6.5 When the burner is established the display will show the 'flame symbol'.

15.7 DOMESTIC HOT WATER

- 15.7.1 With the boiler firing, set the DHW Temperature Control to maximum and fully open a DHW tap. The boiler should continue to run and the display should show the 'flame symbol'.
- 15.7.2 Ensure that with the boiler operating the dynamic gas pressure is able to obtain maximum output.
- 15.7.3 Turn off the DHW tap.

15.8 CHECK THE OPERATIONAL GAS INLET PRESSURE

- 15.8.1 Set up the boiler to operate at maximum rate by opening hot tap to maximum flow.
- 15.8.2 With the boiler operating in the maximum rate condition check the operational gas pressure at the inlet gas pressure test point complies with the requirements.
- 15.8.3 Ensure that this inlet pressure can be obtained with all other gas appliances in the property working.



FIGURE 27

IMPORTANT GENERAL CHECKS

15.9 DOMESTIC HOT WATER (DHW) MODE

- 15.9.1 Fully open all DHW taps in turn and ensure that water flows freely from them.
- 15.9.2 Close all taps except the furthest one from the boiler and check that the boiler is firing at maximum rate. This is factory set to give a DHW temperature rise of approximately 35°C at the flow rate stated Section 5 Technical Data.
- 15.9.3 Reduce the DHW draw-off rate to about 3l/min and check that the boiler modulates to deliver DHW at approximately 60°C.
- 15.9.4 Close the DHW tap and check that the main burner extinguishes. The pump should overrun for 60 seconds.

NOTE: On systems in excess of 2 bar inlet pressure a water pressure governor may be required to prevent water noise.



FIGURE 28.

15.10 CENTRAL HEATING (CH) & DOMESTIC HOT WATER (DHW) MODE

- 15.10.1 Ensure that the CH external controls are calling for heat. The burner should light. Display should read 58°C.
- 15.10.2 Fully open a DHW tap and check that hot water is delivered. Display should read 58°C.

15.10.3 Gas Rate: Check the boiler gas rate when the boiler is at full DHW output. Check at the gas meter, with no other appliance in use. Refer to Tables 1 & 2 for gas rates.

- 15.10.4 Close the DHW tap. The burner should go off and the pump continue to run.
- 15.10.5 Set the central heating external controls to OFF. The burner should go off and the pump continue to run until the CH return temperature falls below 35°C.
- 15.10.6 Check the correct operation of the timer (if fitted) and all other system controls. Operate each control separately and check that the main burner responds.



FIGURE 29.

15.11 FLUSHING THE SYSTEM & WATER CIRCULATION

- 15.11.1 With the system HOT, examine all water connections for tightness. The system pressure will increase with temperature rise but should not exceed 2.5 bar.
 - 15.11.2 With the system still hot, turn off the gas, water and electricity supplies to the boiler and drain down to complete the flushing process.
- NOTE:** A flushing solution should be used during the flushing procedure. Flushing solutions: Fernox Superfloc, Sentinel X300 (new systems) or X400 (existing systems).
- 15.11.3 Refill and vent the system, add inhibitor, clear all air locks and again check for water tightness.
 - 15.11.4 With the system COLD, check that the initial pressure is correct to the system design requirements. For pre-pressurised systems, this should be 1.0 bar.
 - 15.11.5 Reset the system initial pressure to the design requirement.

15.12 BALANCE THE SYSTEM

- 15.12.1 The boiler does not normally need a bypass but at least some radiators on the heating circuit, off load at least 10% of the minimum boiler output, these must be provided with twin lockshield valves so that the minimum heating load is always available. See paragraph 6.1.10 regarding thermostatic radiator valves.

NOTE: Systems incorporating zone valves which could completely cut off the flow through the system must also include a bypass.

15.12.2 BALANCING

- a. Set the programmer to ON.
Close the manual or thermostatic valves on all radiators, leaving the twin lockshield valves (on the radiators referred to above) in the open position.
Turn up the room thermostat and adjust the lockshield valve to give an uninterrupted flow through the radiator.
These valves should now be left as set.
- b. Open all manual or thermostatic radiator valves and adjust the lockshield valves on the remaining radiators, to give around 20°C temperature drop at each radiator.
- c. Adjust the room thermostat and programmer to normal settings.

- 15.12.3 Check the condensate drain for leaks and check that it is discharging correctly.
- 15.12.4 Finally, set the controls to the User's requirements.

NOTE: The pump will operate briefly as a self-check once every 24 hours in the absence of any system demand.

15.13 WATER TEMPERATURES

Temperatures can be selected using the CH and DHW thermostats.

TABLE 6		
Button Setting	CH Flow Temperature	DHW Outlet Temperature
Max	80°C	60°C
Min	45°C	40°C

16. HANDING OVER

- 16.1 Hand the User Instructions to the householder and explain their responsibilities under the relevant national regulations.
- 16.2 This appliance is not intended for use by persons (including children) with reduced physical, sensory or mental capabilities, or lack of experience and knowledge, unless they have supervision or been given instruction concerning use of the appliance by a person responsible for their safety.
- 16.3 Explain and demonstrate the lighting and shutting down procedures.
- 16.4 The operation of the boiler and the use and adjustment of all system controls should be fully explained to the householder, to ensure the greatest possible fuel economy consistent with the household requirements of both heating and hot water consumption. Advise the User of the precautions necessary to prevent damage to the system and to the building, in the event of the system remaining inoperative during frosty conditions.
- 16.5 Explain the function and the use of the boiler heating and domestic hot water controls. Explain that due to system variations and seasonal temperature fluctuations DHW flow rates/temperature rise will vary. This requires adjustment at the draw off tap. It is therefore necessary to show the User the relevant section in the Users Instructions and say the following statement. "Additionally, the temperature can be controlled by the user via the draw-off tap, the lower the rate the higher the temperature, and vice versa".
- 16.6 Explain the function of the boiler fault codes. Emphasise that if a fault is indicated refer to "Fault Codes" in the User Guide.
- 16.7 Explain and demonstrate the function of time and temperature controls, radiator valves etc., for the economic use of the system.
- 16.8 If a timer is fitted draw attention to the timer Users Instructions.
- 16.9 LOSS OF SYSTEM WATER PRESSURE** - Explain that the dial underneath the boiler indicates the central heating system pressure and that if the normal COLD pressure of the system is seen to decrease over a period of time then a water leak is indicated. Explain the re-pressurising procedure and if unable to re-pressurise or if the pressure continues to drop a registered local heating installer should be consulted.
- 16.10 Explain Boiler reset procedure.
- 16.11 After installation and commissioning please complete the Commissioning Checklist before handover to the customer. For IE, it is necessary to complete a "Declaration of Conformity" to indicate compliance to I.S. 813.



IMPORTANT

- 16.12 A comprehensive service should be carried out ANNUALLY. Stress the importance of regular servicing by a Gas Safe Registered Engineer. In IE servicing work must be carried out by a Registered Gas Installer (RGI).

17. SERVICING & MAINTENANCE

17.1 SERVICING SCHEDULE

NOTE: it is a statutory requirement that ALL work is carried out by a "competent person" which in normal circumstances would be a GAS SAFE registered engineer.

- 17.1.1 For the very latest copy of literature for servicing & maintenance instructions, visit our website www.johnsonandstarley.co.uk, where you can download the information.

Warning. Always turn off the gas supply at the gas service cock, and switch OFF and disconnect the electricity supply to the appliance before servicing.

- 17.1.2 Combustion testing must be carried out by a competent person using a combustion analyser conforming to BS 7927.
- 17.1.3 To ensure the continued safe and efficient operation of the appliance it is recommended that it is checked at regular intervals and serviced as necessary. The frequency of servicing will depend upon the installation condition and usage but should be carried out at least annually.
- 17.1.4 It is the law that any service work must be carried out by a Gas Safe Registered Engineer. In IE service work must be carried out by a Registered Gas Installer (RGI).

17.2 INITIAL INSPECTION

- 17.2.1 Light the boiler and carry out a pre-service check, noting any operational faults.
- 17.2.2 Check the flue terminal (and terminal guard if fitted) is undamaged and clear of any obstruction.
- 17.2.3 Check all water and gas joints for signs of leakage. Remake any suspect joints ensuring a gas tightness check is carried out if applicable and the water system is correctly refilled, vented and re-pressurised.

17.3 SERVICING SEQUENCE

NOTE: In order to carry out either servicing or replacement of components the boiler front panel must be removed. paragraph 17.5.

- 17.3.1 Clean the main burner.

- 17.3.2 Clean the heat exchanger & condensate trap/siphon.
- 17.3.3 Check the main injector for blockage or damage.
- 17.3.4 Check that the flue terminal is unobstructed and that the flue system is sealed correctly.
- 17.3.5 After completing the servicing or exchange of components always test for gas tightness.
- 17.3.6 When work is complete the front panel MUST be correctly refitted, ensuring that a good seal is made.
- 17.3.7 Check the gas consumption.
- 17.3.8 Check combustion by connecting the flue gas analyser to the flue gas sampling point and measure the CO & CO². See Figure 30.

If the CO/CO² ratio is greater than 0.004 and the integrity of the complete flue system and combustion circuit seals have been verified and the inlet gas pressure (and gas rate) have been verified, then contact Johnson & Starley Ltd.

- 17.3.9 Once the service is complete, fill in the relevant section in the Benchmark Checklist located at the back of this book



17.4 FLUE INSPECTION & CHECKS

PLEASE NOTE: During routine servicing, and after any maintenance or change of part of the combustion circuit, the following must be checked:

- The integrity of the flue system and the flue seals
- The integrity of the boiler combustion circuit and the relevant seals
- The operational (working) gas inlet pressure at maximum rate.
- The gas rate.
- The combustion performance.

Competence to carry out the check of combustion performance.

PLEASE NOTE: BS 6798 Specification for installation and maintenance of gas-fired boilers of rated input not exceeding 70kW net advises that:

- The person carrying out a combustion measurement should have been assessed as competent in the use of a flue gas analyser and the interpretation of the results.
- The flue gas analyser used should be one meeting the requirements of BS 7927 or BS EN 50379-3 and be calibrated in accordance with the analyser manufacturers requirements.
- Competence can be demonstrated by satisfactory completion of the CPA1 ACS assessment, which covers the use of electronic portable combustion gas analysers in accordance with BS 7967, Parts 1 to 4.



FIGURE 30.
FLUE GAS TEST POINTS

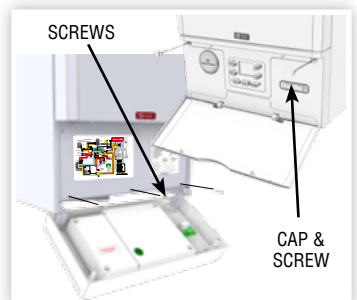

FIGURE 31.
DOOR REMOVAL

GAINING ACCESS TO THE BOILER

17.5 CONTROL PANEL & FRONT DOOR REMOVAL

- 17.5.1 Lower the flip door and remove the 2 screws cover plugs and unscrew the 2 screws. See figure 31. Drop down and move the control panel assembly. See figure 31.
- 17.5.2 To remove the door remove the 5 screws. Lift up forward and remove.
- 17.5.3 Refit in reverse order.

17.6 FAN REMOVAL

Refer to paragraph 17.5

- 17.6.1 Disconnect the front mains electrical connection.
- 17.6.2 Remove the red securing clip, noting its correct position. Slide the fan backwards off the venturi.
- 17.6.3 Remove the second electrical cable from the rear of the fan.
- 17.6.4 Replace with new and refit by aligning the grooves on the side of the fan and slot back into place.
- 17.5.5 Refit in reverse order.



FIGURE 32.
FAN REMOVAL

17.7 BURNER ASSEMBLY REMOVAL

Refer to paragraphs 17.5 and 17.6

- 17.7.1 Remove the gas pipe securing clip. Undo the gas pipe.
- 17.7.2 Remove the ignition/detection and earth leads.
- 17.7.3 Remove the 4 burner fixing nuts using a 10mm spanner.
- 17.7.4 Lift out the burner from the combustion chamber.
- 17.7.5 Brush off any deposits that may be on the burner with a soft brush. Inspect the ignition/detection electrode and check the electrode gaps. See Figure 38.
- 17.7.6 Inspect the black rubber sealing gasket around the burner for any signs of damage. Replace if necessary. The blue rope braid seal should not be removed under any circumstances and it is not a serviceable item.
- 17.7.7 Refit in reverse order.

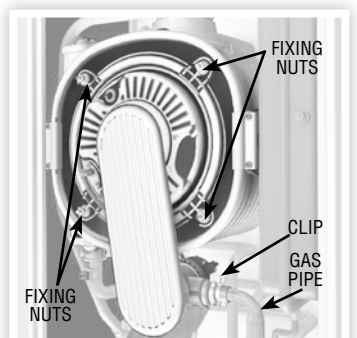

FIGURE 33.
BURNER ARM & HEAT EXCHANGER

17.8 HEAT EXCHANGER

Refer to paragraphs 17.5 to 17.7

- 17.8.1 Inspect the inside of the combustion chamber, with a soft brush remove any deposits that may have occurred. Flush with clean water. DO NOT use any chemicals.
- 17.8.2 Inspect the heat exchangers insulation at the front and back of the combustion chamber for any signs of damage.
- 17.8.3 If there are any signs of damage on the flue outlet then this must be replaced.
- 17.8.4 Check the gaskets of burner door and burner, If they show signs of damage then replace.
- 17.8.5 Refit in reverse order.

17.9 CONDENSATE TRAP

Refer to paragraph 17.5.

- 17.9.1 Unscrew the 2 pipes and pull off the third pipe.
- 17.9.2 Remove the trap and clean by removing the cleaning plug. Flush out any deposits with clean water.
- 17.9.3 Refit the trap and the pipes.
- 17.9.4 Refit in reverse order.



FIGURE 34. CONDENSATE TRAP

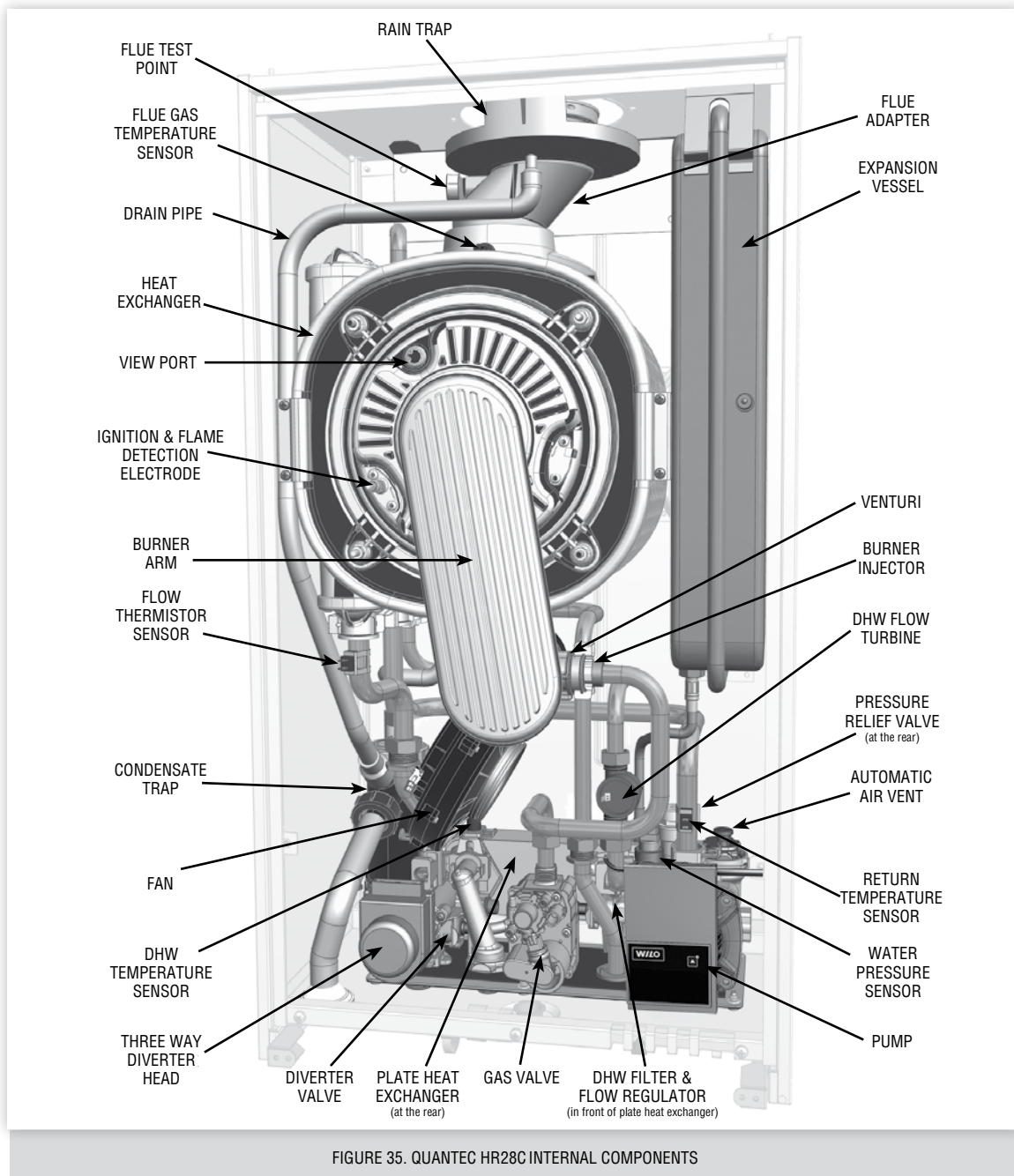

FIGURE 35. QUATEC HR28C INTERNAL COMPONENTS

18. PARTS REPLACEMENT

- 18.1 IMPORTANT:** Before commencing with any part replacement the appliance should be isolated from the electrical supply and the gas service cock on the appliance closed.
- 18.1.1 All parts that are removed should be replaced and refitted in reverse order, ensuring correct seals are made and wires are connected correctly.
 - 18.1.2 Remove any debris from within the appliance.
 - 18.1.3 When gas-carrying components are replaced the appliance must be tested for gas tightness.
 - 18.1.4 On completion carry out a full functional test of all appliance components and ensure system controls are operating correctly.

PART REPLACEMENTS MADE WITHOUT DRAINING THE SYSTEM

18.2 BURNER INJECTOR

- 18.2.1 Refer to paragraph 17.5
- 18.2.2 Remove the gas pipe securing clip from venturi. See Figure 36.
- 18.2.3 Undo the gas pipe union from the gas valve.
- 18.2.4 Withdraw gas pipe from venturi.
- 18.2.5 Remove injector from gas pipe.
- 18.2.6 Replace and refit in reverse order.
- 18.2.7 Check the operation of the boiler. See Section 15.

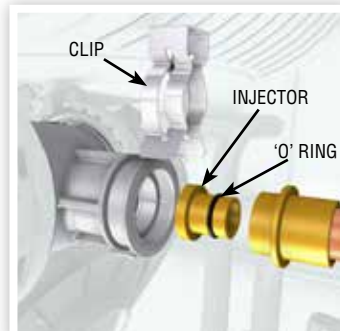

FIGURE 36. BURNER INJECTOR

18.3 BURNER ASSEMBLY/VENTURI

- 18.3.1 Refer to paragraph 17.5
- 18.3.2 Remove the burner assembly. See paragraph 17.7.
- 18.3.3 To replace the venturi, remove the 4 screws and replace with new.
- 18.3.4 Inspect the ignition/detection electrode and check the electrode gaps.
- 18.3.5 Replace with new burner assembly.
- 18.3.6 Replace the sealing gasket around the burner.
- 18.3.7 Refit in reverse order.
- 18.3.8 Check the operation of the boiler. See Section 15.

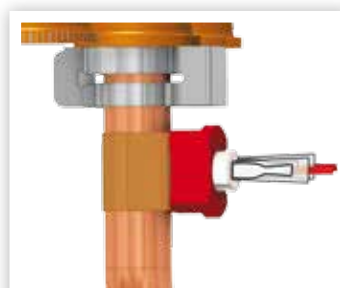

FIGURE 37. THERMISTOR SENSOR

18.4 FLOW & RETURN THERMISTOR SENSORS

- 18.4.1 Refer to paragraph 17.5
- 18.4.2 Unclip the thermistor sensor from the flow/return pipe and withdraw it from the boiler.
- 18.4.3 Disconnect the electrical leads from the thermistors.
- 18.4.4 Reconnect the electrical leads to the new thermistors and re-assemble in reverse order, ensuring that the thermistors are securely.
- 18.4.5 Check the operation of the boiler. See Section 15.

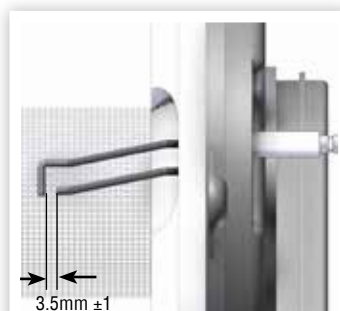

FIGURE 38. ELECTRODE GAP

18.5 IGNITION/DETECTION ELECTRODE

- 18.5.1 Refer to paragraph 17.5
- 18.5.2 Remove the burner. See paragraph 17.7.
- 18.5.3 Remove the 2 torx screws holding the ignition electrode to the combustion chamber.
- 18.5.4 Remove the electrode.
- 18.5.5 Fit the new ignition electrode, using the new gasket supplied. Check dimensions as shown.
- 18.5.6 Refit in reverse order.
- 18.5.7 Check the operation of the boiler. See Section 15

18.6 GAS VALVE

- 18.6.1 Refer to paragraph 17.5
- 18.6.2 Unplug the electrical lead connection from the gas control valve, disconnect the PDT tube.
- 18.6.3 Undo the union nut on the top of the gas control valve.
- 18.6.4 Undo the gas inlet pipe union underneath the cabinet to the gas control valve.
- 18.6.5 Remove the 2 screws retaining the valve to the bracket and withdraw.
- 18.6.6 Fit the new gas control valve ensuring the two sealing washers are in place and reconnect gas, electrical connection and PDT tube.
- 18.6.7 Check operation of the boiler. See Section 15.

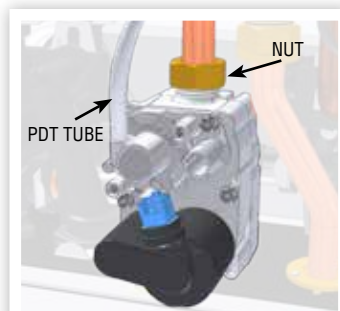

FIGURE 39. GAS VALVE

18.7 DIVERTER VALVE ACTUATOR HEAD

- 18.7.1 Refer to paragraph 17.5
- 18.7.2 Remove the electrical connection.
- 18.7.3 Pull out the retaining clip and lift out the diverter head.
- 18.7.4 Fit new actuator head and refit in reverse order.
- 18.7.5 Check operation of the boiler. See Section 15.

18.8 CONDENSATE TRAP/SIPHON

- 18.8.1 Refer to paragraph 17.5 and 17.9
- 18.8.2 Replace and refit in reverse order.

18.9 PCB ASSEMBLY

- 18.9.1 Refer to paragraph 17.5
- 18.9.2 Remove the 4 screws retaining the control box cover.
- 18.9.3 Unplug all lead connections to the PCB assembly
- 18.9.4 Remove 4 PCB fixing screws, remove PCB and fit new.
- 18.9.5 Re-connect all plug connections.
- 18.9.6 Refit in reverse order.
- 18.9.7 Turn power back on to the boiler, after a few moments the boiler will start 'purge cycle' this can be cancelled by pressing reset. Refer to the fitting instructions with the spare for programming.
- 18.9.8 Check operation of the boiler. See Section 15.

18.10 DHW FLOW TURBINE SENSOR

- 18.10.1 Refer to paragraph 17.5
- 18.10.2 Shut of mains cold water using DHW inlet valve (D) and drain water from the system using sink and bathroom taps. See paragraph 18.12.
- 18.10.3 Undo the 2 unions on each side of the turbine.
- 18.10.4 Unplug the electrical connection and transfer to new turbine sensor.
- 18.10.5 Replace washer and refit in reverse order.
- 18.10.6 Check operation of the boiler. See Section 15.

DRAINING THE APPLIANCE & SYSTEM

18.11 CENTRAL HEATING CIRCUIT

- 18.11.1 Refer to paragraph 17.5. See Figure 24.
- 18.11.2 Close all the CH water isolating valves (A) and (E) on the boiler inlet.
- 18.11.3 To drain the primary heat exchanger circuit. Attach a length of hose to the CH drain point (I) then open the drain valve.
- 18.11.4 After replacing any component on the boiler, close the drain valve, remove the hose and open all system isolating valves (re-pressurise as appropriate by re-connecting the filling loop) before proceeding to check operation of the boiler.
- 18.11.5 Disconnect filling loop.
- 18.11.6 Check operation of the boiler. See Section 15.

18.12 DOMESTIC HOT WATER CIRCUIT

- 18.12.1 Refer to paragraph 17.5
- 18.12.2 Close all the DHW water isolating valves on the boiler inlet.
- 18.12.3 To drain the DHW circuit: As there is no direct drain for the DHW circuit, depending on the location of the boiler, opening the lowest hot water tap may drain this circuit. However it must be noted that some residual water will be experienced during replacement of components.
- 18.12.4 After replacing any component on the boiler, close tap, open the DHW isolation valve and purge air out of the pipe work.
- 18.12.5 Check operation of the boiler. See Section 15.

18.13 PRESSURE GAUGE

- 18.13.1 See 18.11 to drain system.
- 18.13.2 Unscrew the pressure gauge and discard.
- 18.13.3 Fit new pressure gauge, using suitable jointing compound.
- 18.13.4 Refill the boiler. See paragraph 14.5.
- 18.13.5 Check operation of the boiler. See Section 15.

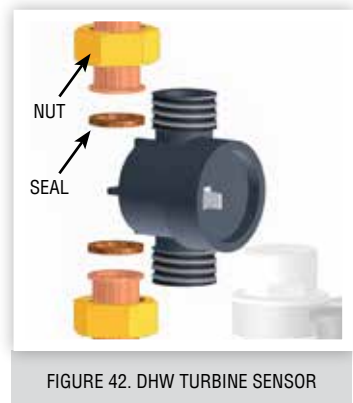
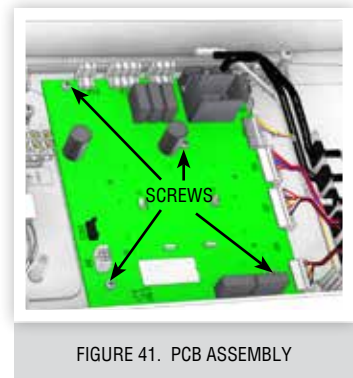
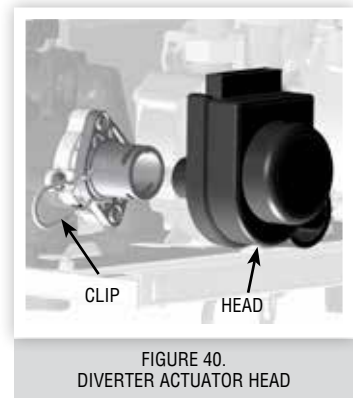

18.14 SAFETY PRESSURE RELIEF VALVE

- 18.14.1 Drain CH circuit. See paragraph 18.11.
- 18.14.2 Withdraw the clip securing the safety valve.
- 18.14.3 Undo the safety valve union connection.
- 18.14.4 Remove and refit new valve.
- 18.14.5 Refit in reverse order.
- 18.14.6 Refill boiler. See paragraph 14.5.
- 18.14.7 Check operation of boiler. See Section 15.

18.15 AUTOMATIC AIR VENT

- 18.15.1 Drain CH circuit. See paragraph 18.11.
- 18.15.2 The automatic air vent head is retained in the pump body with a 'U' clip. Remove clip and lift upwards.
- 18.15.3 Replace and refit in reverse order. Ensure the air vent head 'O' ring seal is in place when refitting and the new 'O' ring is fitted to the return pipe top connection.
- 18.15.4 Ensure the air vent cap is loose.
- 18.15.5 Refill the boiler. See paragraph 14.5. Check for leaks around the new air vent joint.
- 18.15.6 Check the operation of the boiler. See Section 15.

18.16 DIVERTER VALVE INTERNAL CARTRIDGE

- 18.16.1 Refer to paragraph 17.5.
- 18.16.2 Drain the boiler. See paragraph 18.11.
- 18.16.3 Remove the diverter valve head. See paragraph 18.7.
- 18.16.4 Unscrew the 2 screws to access the internal cartridge.
- 18.16.5 Lubricate the new cartridge with silicone grease and replace.
- 18.16.6 Refit in reverse order.
- 18.16.7 Refill the boiler. See paragraph 14.5.
- 18.16.8 Check operation of the boiler. See Section 15.

18.17 DHW PLATE HEAT EXCHANGER

- 18.17.1 Refer to paragraph 17.5. See Figure 47
 - 18.17.2 Drain the boiler. See paragraph 18.11 and 18.12.
 - 18.17.3 Remove the fan. See paragraph 17.6.
 - 18.17.4 Remove 2 allen screws securing the plate heat exchanger to the housings enough to remove.
 - 18.17.5 Manoeuvre the plate heat exchanger out through space left by the fan.
 - 18.17.6 Fit the new plate heat exchanger, using the new O-rings supplied.
- NOTE:** The mounting pins are offset. See Figure 47.
- 18.17.7 Refit in reverse order.
 - 18.17.8 Refill the boiler. See paragraph 14.5.
 - 18.17.9 Check operation of the boiler. See Section 15.

18.18 PUMP HEAD/PWM HIGH EFFICIENCY PUMP HEAD

- 18.18.1 Refer to paragraph 17.5
- 18.18.2 Drain the boiler. See paragraph 18.11.
- 18.18.3 Disconnect the electrical lead from the pump.
- 18.18.4 Remove the 4 allen screws retaining the pump head.
- 18.18.5 Remove the pump head and refit new.
- 18.18.6 When fitting the new PMW pump head there is a loose 2 way connector.
- 18.18.7 Refit in reverse order.
- 18.18.8 Refill the boiler. Refer to paragraph 14.5
- 18.18.9 Check operation of the boiler. See Section 15.
- 18.18.10 If you have replace a standard pump with a new HE pump, as follows
 - a. Press and hold the K1 & K7 buttons approx 10 second until the LED flashes with 't 5'.
 - b. Quickly press and release the RESET (K4) button. The LED will display P00.
 - c. Using the HOT WATER + (K7) button scroll the display to P27.

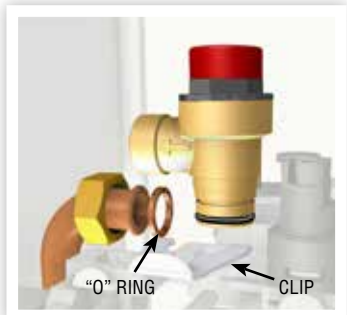

FIGURE 44. PRESSURE RELIEF VALVE



FIGURE 45. AUTOMATIC AIR VENT

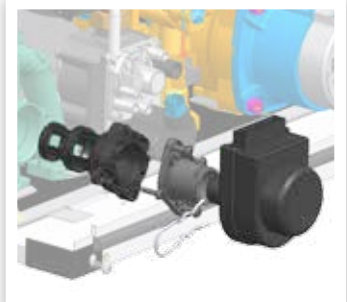

FIGURE 46. DIVERTER CARTRIDGE

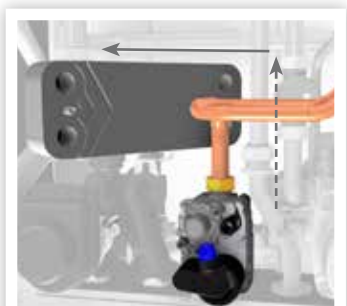

FIGURE 47. PLATE HEAT EXCHANGER



FIGURE 48. PUMP HEAD

- d. Using either CH+ (K1) or CH - (K2) buttons select either 0 or 1.
 - '0' is for the fixed speed standard efficiency pump.
 - '1' is for the PWM High Efficiency pump.
- e. Press and release RESET (K4) button to return the display to P 27.
- f. Exit installer mode by pressing and releasing RESET again for 't 5' to flash followed by pressing and releasing 'K5' (K5).

NOTE: When replacing the pump head with the new PWM High Efficiency Pump Head refer to the instructions with the kit for commissioning.

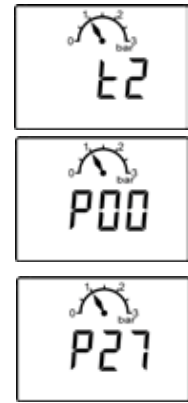

FIGURE 49.
READ OUTS

18.19 CH WATER PRESSURE SENSOR

- 18.19.1 Refer to paragraph 17.5
- 18.19.2 Drain the boiler. See paragraph 18.11.
- 18.19.3 Using a suitable tool pull out the retaining clip.
- 18.19.4 Pull the pressure sensor upwards to remove.
- 18.19.5 Unplug the electrical connection and transfer to the new pressure sensor.
- 18.19.6 Push the new pressure sensor onto the rear pump housing and fit retaining clip.
- 18.19.7 Refit in reverse order.
- 18.19.8 Refill the boiler. See paragraph 12.4.
- 18.19.9 Check operation of the boiler. See Section 15.

18.20 DHW FILTER & FLOW REGULATOR

- 18.20.1 Refer to paragraph 17.5
- 18.20.2 Remove the flow turbine. See paragraph 18.10.
- 18.20.3 Remove the clip securing the pipe to housing.
- 18.20.4 Withdraw the filter and flow regulator.
- 18.20.5 Replace and refit in reverse order.
- 18.20.6 Refill the boiler. See paragraph 12.4.
- 18.20.7 Check operation of the boiler. See Section 15.

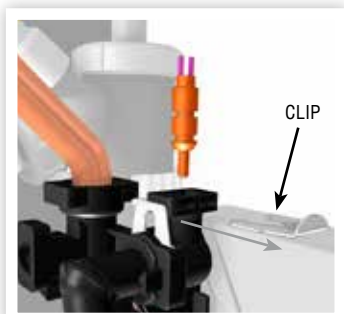

FIGURE 50.
CH WATER PRESSURE SENSOR

18.21 EXPANSION VESSEL

RECHARGING

- 18.21.1 Refer to paragraph 17.5
- 18.21.2 Relieve system pressure through a CH drain point.
- 18.21.3 Remove the charge point cover.
- 18.21.4 Recharge the tank pressure to 0.75 - 1 bar.
- 18.21.5 Refit in reverse order
- 18.21.6 Check operation of the boiler. See Section 15.

REPLACEMENT

- 18.21.7 Refer to paragraph 17.5
- 18.21.8 Drain the boiler CH circuit. See paragraph 18.11.
- 18.21.9 Remove the clip from the base of the silver hose.
- 18.21.10 Remove the top bracket by removing the single screw, remove the bracket.
- 18.21.11 Slide the expansion vessel forward with the hose attached.

NOTE: It is advised you take the expansion vessel outside when removing the hose. Cover the hose connection at the vessel with a cloth when removing the hose. Remember this is a pressurised container and will contain pressurised water.



FIGURE 51. EXPANSION VESSEL

- 18.21.12 Replace and refit in reverse order.
- 18.21.13 Refill the boiler. See paragraph 14.5.
- 18.21.14 Check operation of the boiler. See Section 5.

18.22 FLUE SENSOR

- 18.22.1 To remove the rotate the sensor so the pins are vertical. Pull out and replace with new.
- 18.22.2 Rotate the sensor to lock into position.

FIGURE 52.
SENSOR TEMPERATURE/RESISTANCE DIAGRAM

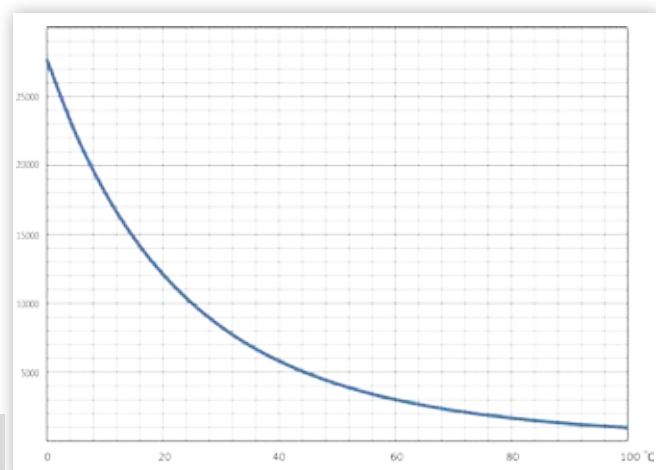

19. FAULT FINDING FLOWCHARTS

Should a fault occur, the boiler will shut down and these error codes will be displayed.

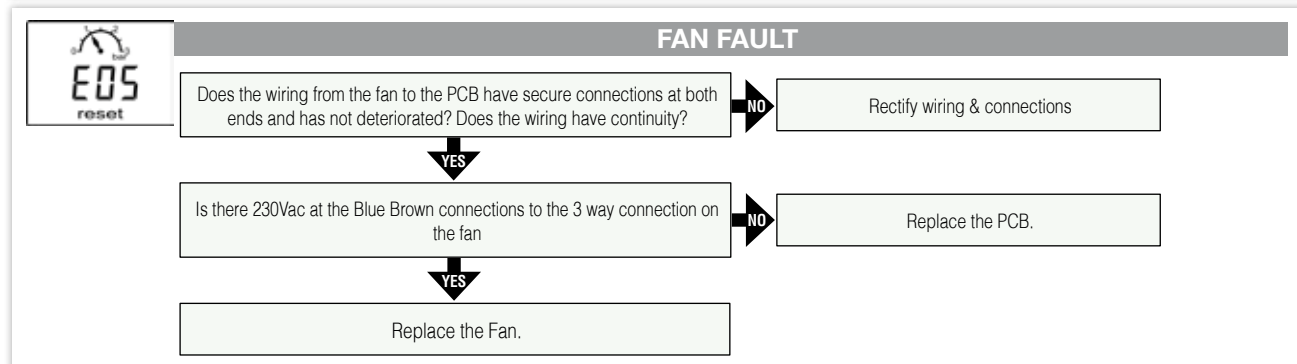
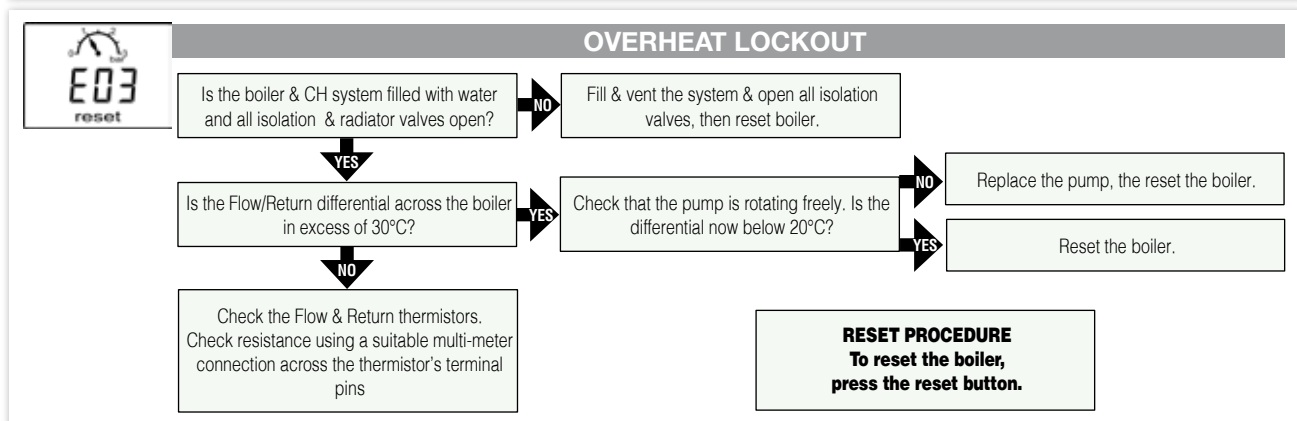
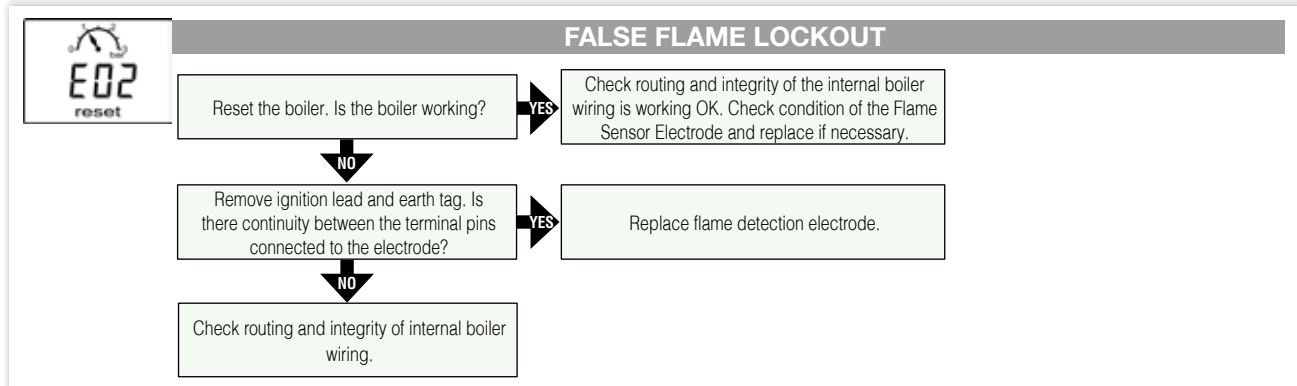
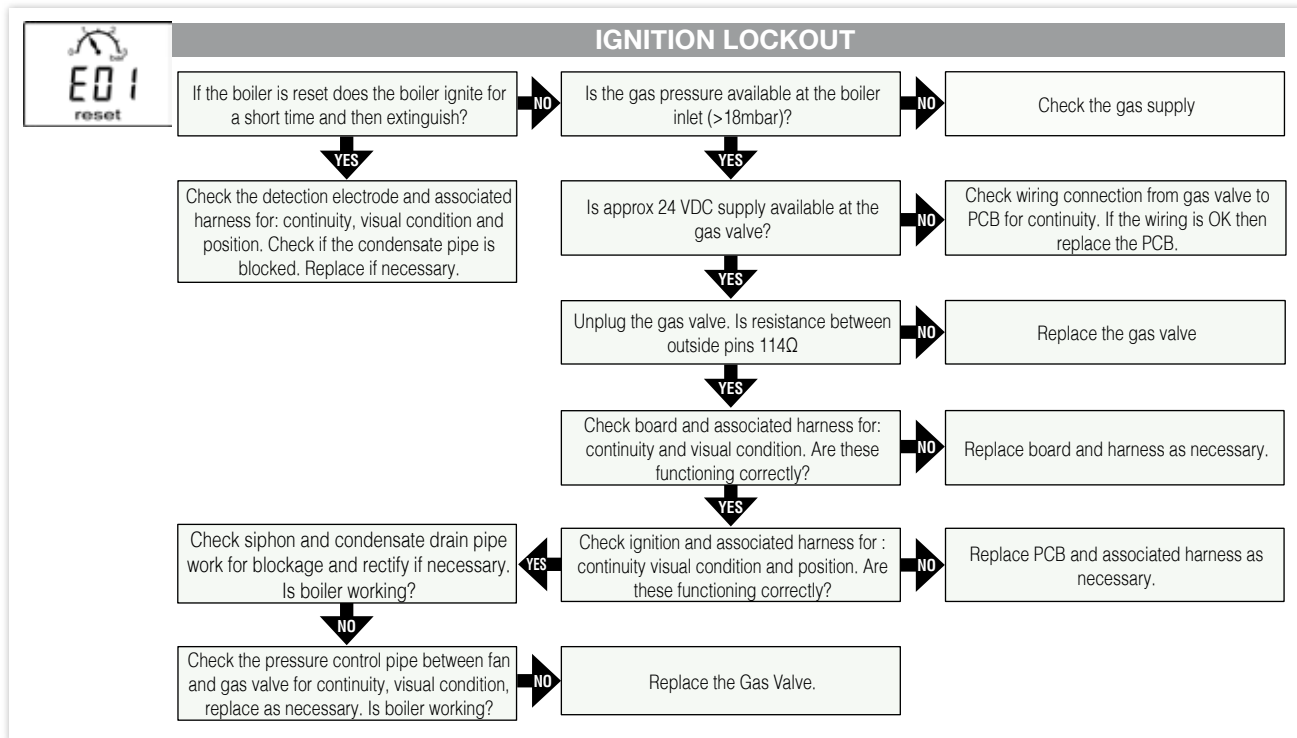

E08 reset **FLAME CIRCUIT FAILURE**

Replace the PCB.

E09 reset **VALVE FEED BACK ERROR**

Unplug the Gas Valve. Is there resistance between pins 114Ω. **NO** → Replace Gas Valve.

YES → Replace Board.

E12 reset **EEPROM LOCKOUT**

Replace the PCB.

E15 reset **FLOW/RETURN SENSOR CALIBRATION CHECK**

Is the boiler & CH system filled with water & all isolation valves open? **NO** → Fill and vent the system and open all isolation valves, check as supply, then reset boiler

YES → Reset the boiler. Is the boiler working? **NO** → Replace the Flow/Return Sensor.

E16 reset **SENSOR STUCK LOCKOUT**

Is the boiler filled with water and all isolation valves open? **NO** → Fill and vent the system and open all isolation valves, check as supply, then reset boiler

YES → **E17 reset** Are the sensors secured firmly to the flow and return pipes? **NO** → Secure Sensors and reset.

YES → **E18 reset** Check resistance at 2 different temperatures. See Graph Figure 51. **NO** → Replace Sensor.

YES → Does the flow pipe temperature increase by more than 1°C within 30 seconds of ignition? **NO** → Check pump is rotating.

YES → Replace the PCB.

E21 reset **ADC LOCKOUT**

Replace the PCB.

E33 reset **RETURN THERMISTOR FAULT**

Remove the return thermistor from the CH return pipe and disconnect the wires. Check the resistance using a suitable multi-meter connected across the thermistor's terminal pins. Is the thermistor valve correct? **NO** → Fit a new Thermistor.

YES → Is the wiring securely connected to the low voltage 9 way connector X5 on the PCB? **NO** → Check and replace wiring as necessary.

YES → Replace the PCB.

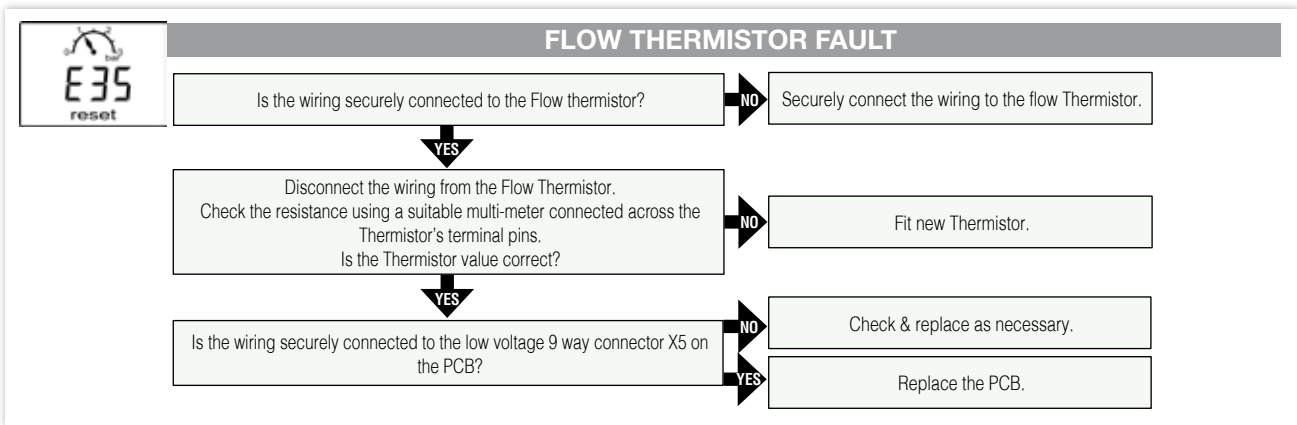

BLOCKING CODES

Should a fault occur, the boiler will shut down and these blocking codes will be displayed.

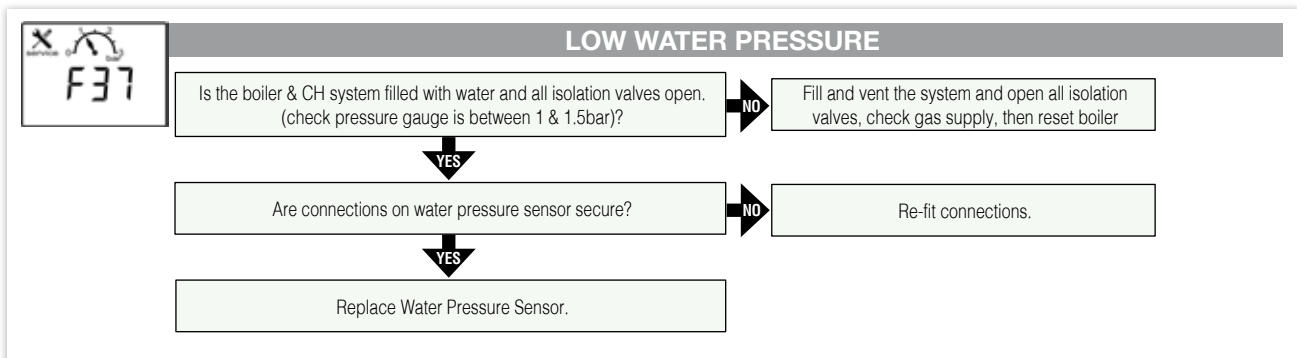
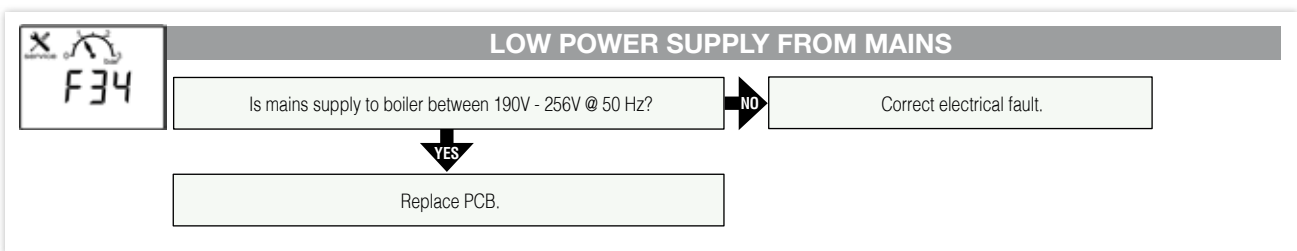
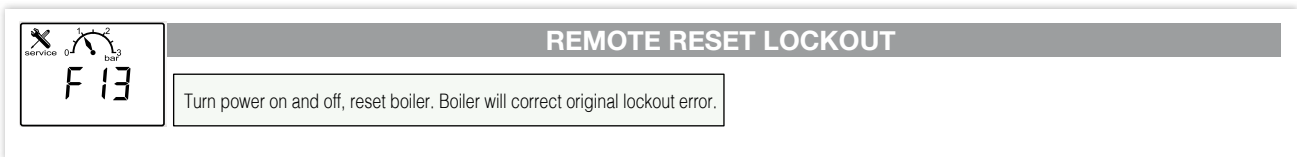
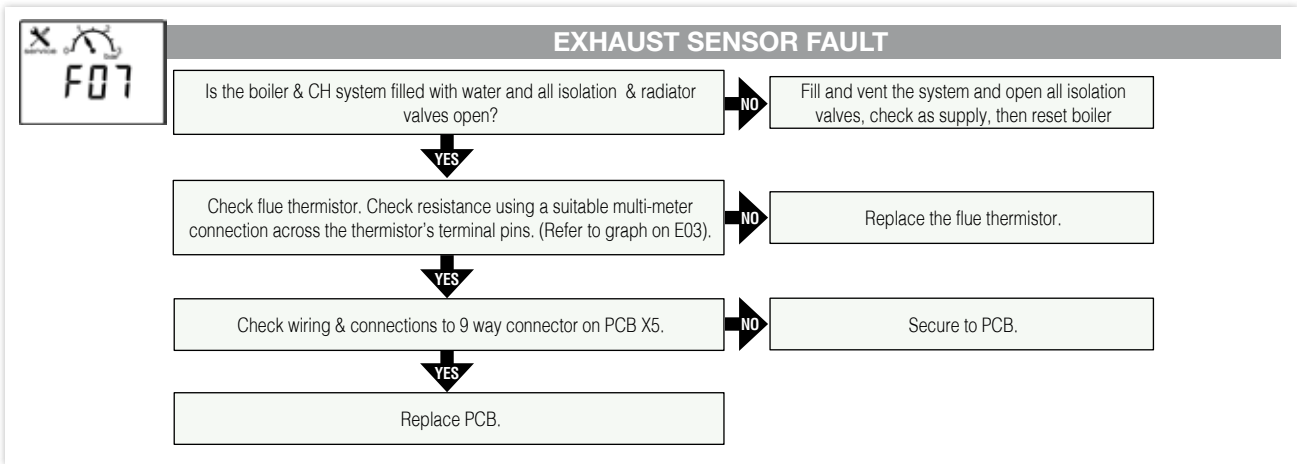



OUTDOOR SENSOR ERROR

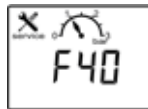
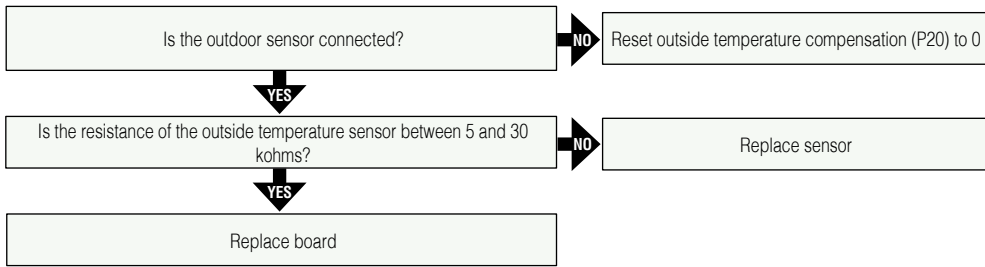

WATER PRESSURE TOO HIGH

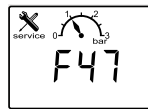
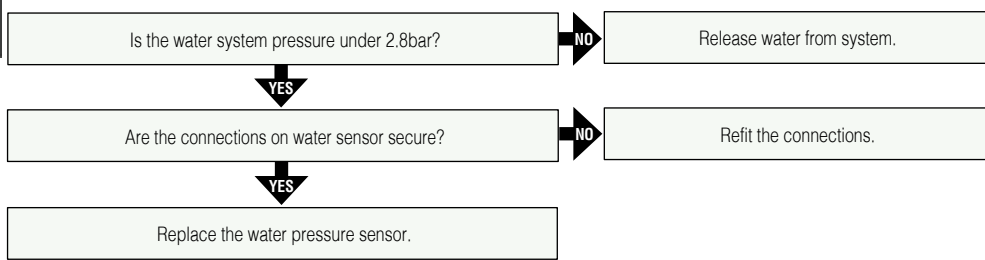

WATER PRESSURE SENSOR

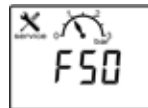
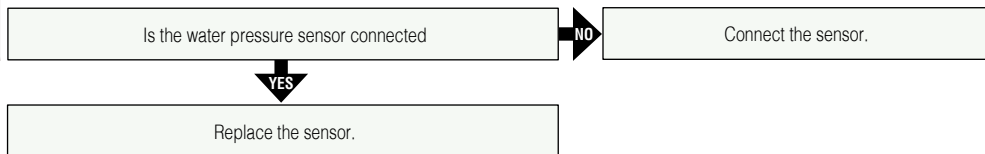

HE DHW OUTLET SENSOR

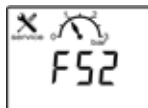

DHW SENSOR LOCKOUT

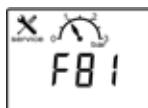
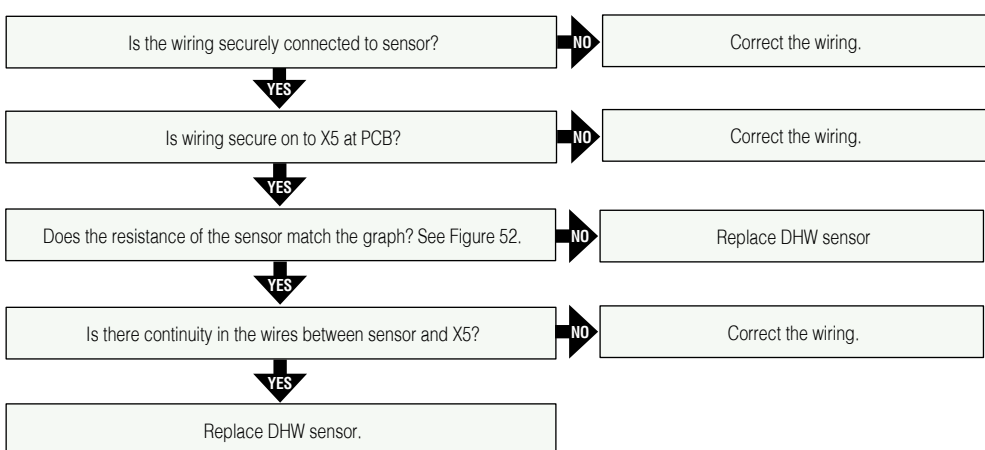

DRIFT TEST WAITING

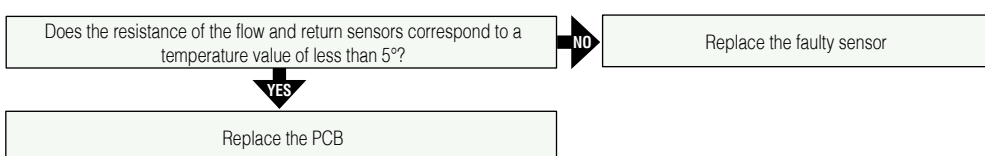

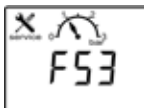

FLUE TEMPERATURE SENOR LOCKOUT

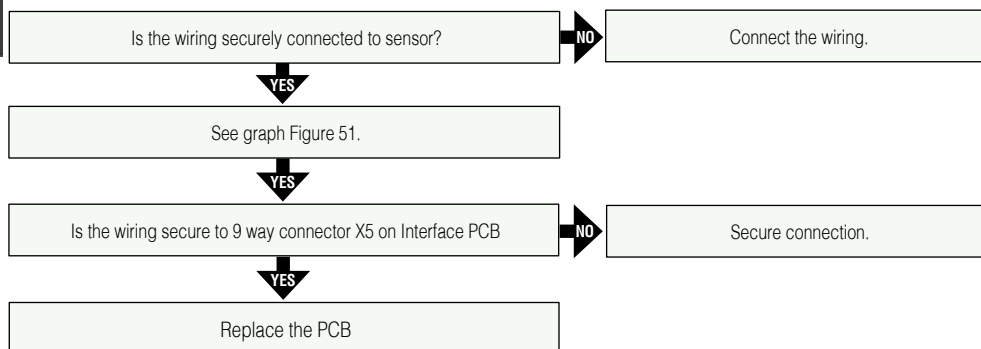

NO DISPLAY

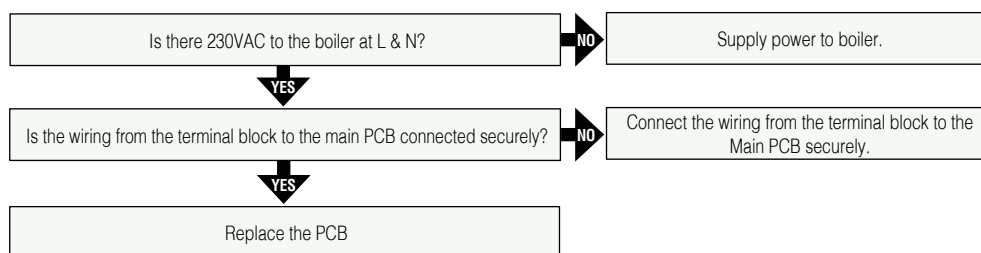

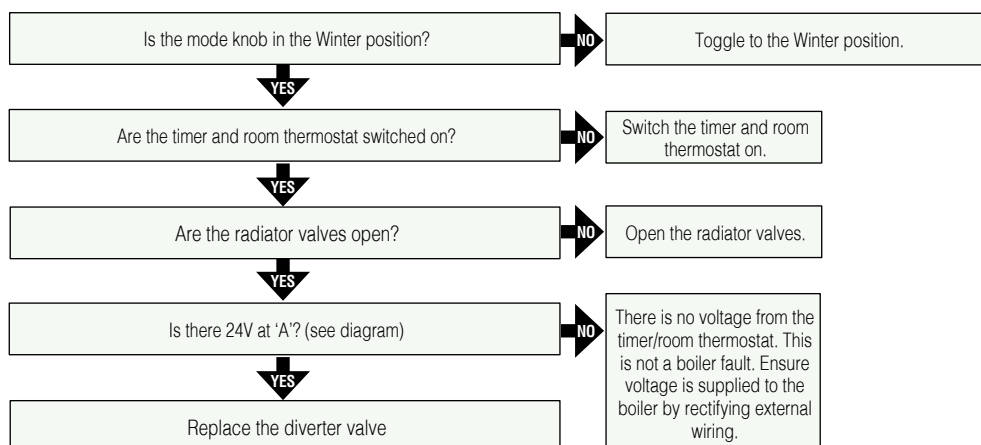

NO CH OPERATION BUT DHW WORKS OK



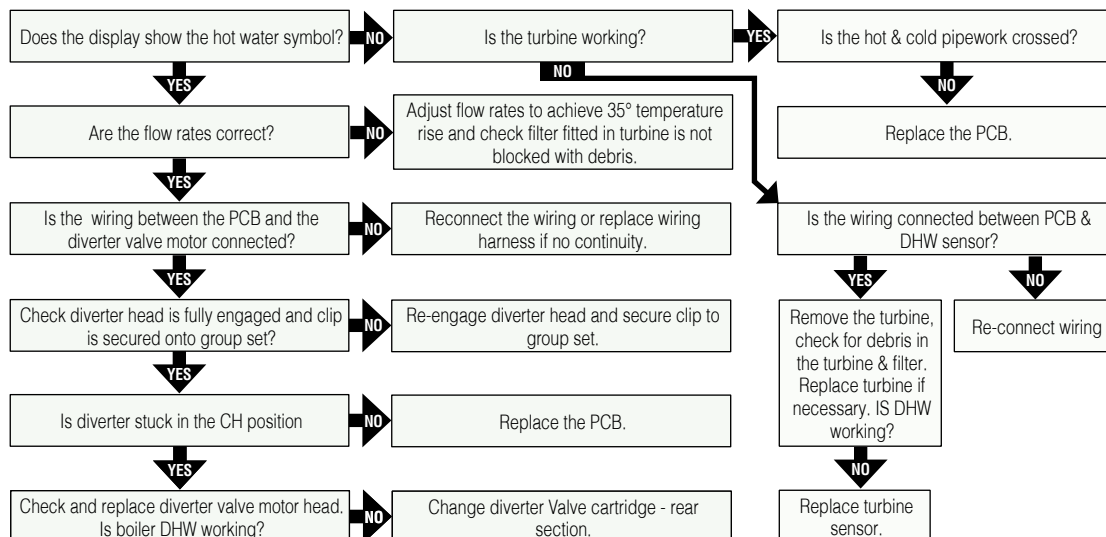









NO DHW BUT CH ON

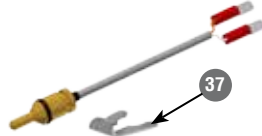

20. LIST OF SPARES

ITEM	DESCRIPTION	QTY	PART No.	G. C. No.	
1	PCB Assembly	1	1000-0526425	J21-296	
2	High Efficiency Pump Head <i>Includes 3 - 6</i>	1	1000-0302415		
3	<i>Pump Head Gasket</i>	1	1000-1508930	J21-281	
4	<i>Pump Lead</i>	1	1000-0530220		
5	<i>Pump Lead</i>	1	1000-0530200		
6	<i>M6 x Long Socket HD Cap Screws</i>	4	1000-3004290		
7	Burner Arm Assembly <i>Includes 8 - 12</i>	1	1000-0711815	J21-313	
8	<i>Burner Arm Fibre Seal Braid Gasket</i>	1	not available		
9	<i>Burner Door Seal</i>	1	1000-1508960	J21-237	
10	<i>Venturi Gasket</i>	1	1000-1508630	J21-243	
11	<i>M5 Screws</i>	4	1000-3003330	J21-244	
12	<i>M6 Nuts</i>	4	1000-3004580	J21-238	
13	Ignition/Detection Electrode <i>Includes 14 - 15</i>	1	1000-0711785	J21-229	
14	<i>Electrode Gasket</i>	1	1000-2501270	H38-677	
15	<i>M4 x 8 Torx Screws</i>	2	1000-3003390	J21-240	
16	Plate Heat Exchanger <i>Includes 17</i>	1	1000-0301955	J21-287	
17	<i>Sealing Rings</i>	4	1000-2501940	J21-288	
18	Gas Valve <i>Includes 19 - 21</i>	1	1000-0710925	J21-261	
19	<i>Top Sealing Washer</i>	1	1000-3004280	J21-231	
20	<i>Bottom Sealing Washer</i>	1	1000-2501880	J24-679	
21	<i>M4 x 10 Screws</i>	2	1000-3000010	J24-680	
22	Combustion Air Fan <i>Includes 23</i>	1	1000-0526415	J21-313	
23	<i>Combustion Air Fan Clip</i>	1	1000-0711745	J21-245	
24	Venturi (034)	1	1000-0710785	J21-232	
25	Injector (4.75) <i>Includes 26</i>	1	1000-0711135	J21-234	
26	<i>'O' Ring</i>	1	1000-2501860	J21-235	

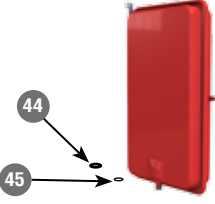
27	DHW Flow Turbine Sensor	1	1000-0526465	J21-262	
28	Pressure Relief Valve <i>Includes 29 - 30</i>	1	1000-0023235	J21-269	
29	<i>Washer</i>	1	1000-3002060	J21-286	
30	<i>Clip</i>	1	1000-3003910	J24-734	
31	Auto Air Vent	1	1000-0023275	J21-271	
32	CH Pressure Sensor <i>Includes 33 to 35</i>	1	1000-0525555	J21-268	
33	<i>15mm 'O' Ring</i>	1			
34	<i>Clip</i>	1	1000-0019600		
35	<i>CH Pressure Sensor Harness</i>	1	1000-0526945	J21-278	
36	DHW Temperature Sensor <i>Includes 37</i>	1	1000-0302195	J21-267	
37	<i>Clip</i>	1	1000-3003920		
38	Flow/Return Temperature Sensor	1	1000-0526515	J24-700	
39	Flue Sensor	1	1000-0526525	J21-253	
40	Diverter Cartridge	1	1000-0025015	J21-265	
41	Diverter Head & Clip	1	1000-0525575	J21-263	
42	Condensate Trap	1	1000-0024525	J21-264	
43	Expansion Vessel <i>Includes 42 - 43</i>	1	1000-0019005	J21-251	
44	<i>Fibre Washer</i>	1	1000-3003170	H39-002	
45	<i>Grommet</i>	1	1000-2500150		

Code Of Practice

For the installation, commissioning and servicing of domestic heating and hot water products

Benchmark places responsibilities on both manufacturers and installers.* The purpose is to ensure that customers** are provided with the correct equipment for their needs, that it is installed, commissioned and serviced in accordance with the manufacturer's instructions by competent persons and that it meets the requirements of the appropriate Building Regulations. Installers are required to carry out work in accordance with the following:

Standards of Work

- Be competent and qualified to undertake the work required.
- Install, commission, service and use products in accordance with the manufacturer's instructions provided.
- Ensure that where there is responsibility for design work, the installation is correctly sized and fit for purpose.
- Meet the requirements of the appropriate Building Regulations. Where this involves notifiable work be a member of a Competent Persons Scheme or confirm that the customer has notified Local Authority Building Control (LABC), prior to work commencing.
- Complete all relevant sections of the Benchmark Checklist/Service Record when carrying out commissioning or servicing of a product or system.
- Ensure that the product or system is left in a safe condition and, whenever possible, in good working order.
- Highlight to the customer any remedial or improvement work identified during the course of commissioning or servicing work.
- Refer to the manufacturer's helpline where assistance is needed.
- Report product faults and concerns to the manufacturer in a timely manner.

Customer Service

- Show the customer any identity card that is relevant to the work being carried out prior to commencement or on request.
- Give a full and clear explanation/demonstration of the product or system and its operation to the customer.
- Hand over the manufacturer's instructions, including the Benchmark Checklist, to the customer on completion of an installation.
- Obtain the customer's signature, on the Benchmark Checklist, to confirm satisfactory demonstration and receipt of manufacturer's instructions.
- Advise the customer that regular product servicing is needed, in line with manufacturers' recommendations, to ensure that safety and efficiency is maintained.
- Respond promptly to calls from a customer following completion of work, providing advice and assistance by phone and, if necessary, visiting the customer.
- Rectify any installation problems at no cost to the customer during the installer's guarantee period.



*The use of the word "installer" is not limited to installation itself and covers those carrying out installation, commissioning and/or servicing of heating and hot water products, or the use of supporting products (such as water treatment or test equipment).

**Customer includes householders, landlords and tenants.

GAS BOILER SYSTEM COMMISSIONING CHECKLIST

This Commissioning Checklist is to be completed in full by the competent person who commissioned the boiler as a means of demonstrating compliance with the appropriate Building Regulations and then handed to the customer to keep for future reference.

Failure to install and commission according to the manufacturer's instructions and complete this Benchmark Commissioning Checklist will invalidate the warranty. This does not affect the customer's statutory rights.

Customer name:	Telephone number:
Address:	
Boiler make and model:	
Boiler serial number:	
Commissioned by (PRINT NAME):	Gas Safe register number:
Company name:	Telephone number:
Company address:	
Commissioning date:	
To be completed by the customer on receipt of a Building Regulations Compliance Certificate*	
Building Regulations Notification Number (if applicable):	

CONTROLS (tick the appropriate boxes)			
Time and temperature control to heating	Room thermostat and programmer/timer	<input type="checkbox"/>	Programmable room thermostat
	Load/weather compensation	<input type="checkbox"/>	Optimum start control
Time and temperature control to hot water	Cylinder thermostat and programmer/timer	<input type="checkbox"/>	Combination Boiler
Heating zone valves	Fitted	<input type="checkbox"/>	Not required
Hot water zone valves	Fitted	<input type="checkbox"/>	Not required
Thermostatic radiator valves	Fitted	<input type="checkbox"/>	Not required
Automatic bypass to system	Fitted	<input type="checkbox"/>	Not required
Boiler interlock		<input type="checkbox"/>	Provided

ALL SYSTEMS			
The system has been flushed and cleaned in accordance with BS7593 and boiler manufacturer's instructions			Yes <input type="checkbox"/>
What system cleaner was used?			
What inhibitor was used?			Quantity litres
Has a primary water system filter been installed?			Yes <input type="checkbox"/> No <input type="checkbox"/>

CENTRAL HEATING MODE measure and record:			
Gas rate	m ³ /hr	OR	ft ³ /hr
Burner operating pressure (if applicable)	mbar	OR Gas inlet pressure	mbar
Central heating flow temperature			°C
Central heating return temperature			°C

COMBINATION BOILERS ONLY			
Is the installation in a hard water area (above 200ppm)?			Yes <input type="checkbox"/> No <input type="checkbox"/>
If yes, and if required by the manufacturer, has a water scale reducer been fitted?			Yes <input type="checkbox"/> No <input type="checkbox"/>
What type of scale reducer has been fitted?			

DOMESTIC HOT WATER MODE Measure and Record:			
Gas rate	m ³ /hr	OR	ft ³ /hr
Burner operating pressure (at maximum rate)	mbar	OR Gas inlet pressure at maximum rate	mbar
Cold water inlet temperature			°C
Hot water has been checked at all outlets			Yes <input type="checkbox"/> Temperature °C
Water flow rate			l/min

CONDENSING BOILERS ONLY	
The condensate drain has been installed in accordance with the manufacturer's instructions and/or BS5546/BS6798	
Yes <input type="checkbox"/>	

ALL INSTALLATIONS					
Record the following:	At max. rate:	CO	ppm	AND	CO/CO ₂ Ratio
	At min. rate: (where possible)	CO	ppm	AND	CO/CO ₂ Ratio
The heating and hot water system complies with the appropriate Building Regulations					Yes <input type="checkbox"/>
The boiler and associated products have been installed and commissioned in accordance with the manufacturer's instructions					Yes <input type="checkbox"/>
The operation of the boiler and system controls have been demonstrated to and understood by the customer					Yes <input type="checkbox"/>
The manufacturer's literature, including Benchmark Checklist and Service Record, has been explained and left with the customer					Yes <input type="checkbox"/>

Commissioning Engineer's Signature
Customer's Signature
(To confirm satisfactory demonstration and receipt of manufacturer's literature)

*All installations in England and Wales must be notified to Local Authority Building Control (LABC) either directly or through a Competent Persons Scheme. A Building Regulations Compliance Certificate will then be issued to the customer.



SERVICE RECORD

It is recommended that your heating system is serviced regularly and that the appropriate Service Interval Record is completed.

Service Provider

Before completing the appropriate Service Record below, please ensure you have carried out the service as described in the manufacturer's instructions. Always use the manufacturer's specified spare part when replacing controls.

SERVICE 01					Date:
Engineer name:					
Company name:					
Telephone No:					
Gas safe register No:					
Record:	At max. rate:	CO	ppm	AND	CO ₂ %
	At min. rate: (Where Possible)	CO	ppm	AND	CO ₂ %
Comments:					
Signature					

SERVICE 02					Date:
Engineer name:					
Company name:					
Telephone No:					
Gas safe register No:					
Record:	At max. rate:	CO	ppm	AND	CO ₂ %
	At min. rate: (Where Possible)	CO	ppm	AND	CO ₂ %
Comments:					
Signature					

SERVICE 03					Date:
Engineer name:					
Company name:					
Telephone No:					
Gas safe register No:					
Record:	At max. rate:	CO	ppm	AND	CO ₂ %
	At min. rate: (Where Possible)	CO	ppm	AND	CO ₂ %
Comments:					
Signature					

SERVICE 04					Date:
Engineer name:					
Company name:					
Telephone No:					
Gas safe register No:					
Record:	At max. rate:	CO	ppm	AND	CO ₂ %
	At min. rate: (Where Possible)	CO	ppm	AND	CO ₂ %
Comments:					
Signature					

SERVICE 05					Date:
Engineer name:					
Company name:					
Telephone No:					
Gas safe register No:					
Record:	At max. rate:	CO	ppm	AND	CO ₂ %
	At min. rate: (Where Possible)	CO	ppm	AND	CO ₂ %
Comments:					
Signature					

SERVICE 06					Date:
Engineer name:					
Company name:					
Telephone No:					
Gas safe register No:					
Record:	At max. rate:	CO	ppm	AND	CO ₂ %
	At min. rate: (Where Possible)	CO	ppm	AND	CO ₂ %
Comments:					
Signature					

SERVICE 07					Date:
Engineer name:					
Company name:					
Telephone No:					
Gas safe register No:					
Record:	At max. rate:	CO	ppm	AND	CO ₂ %
	At min. rate: (Where Possible)	CO	ppm	AND	CO ₂ %
Comments:					
Signature					

SERVICE 08					Date:
Engineer name:					
Company name:					
Telephone No:					
Gas safe register No:					
Record:	At max. rate:	CO	ppm	AND	CO ₂ %
	At min. rate: (Where Possible)	CO	ppm	AND	CO ₂ %
Comments:					
Signature					

SERVICE 09					Date:
Engineer name:					
Company name:					
Telephone No:					
Gas safe register No:					
Record:	At max. rate:	CO	ppm	AND	CO ₂ %
	At min. rate: (Where Possible)	CO	ppm	AND	CO ₂ %
Comments:					
Signature					

SERVICE 10					Date:
Engineer name:					
Company name:					
Telephone No:					
Gas safe register No:					
Record:	At max. rate:	CO	ppm	AND	CO ₂ %
	At min. rate: (Where Possible)	CO	ppm	AND	CO ₂ %
Comments:					
Signature					

*All installations in England and Wales must be notified to Local Authority Building Control (LABC) either directly or through a Competent Persons Scheme. A Building Regulations Compliance Certificate will then be issued to the customer.





sustainable solutions
under one roof

Johnson & Starley Ltd

Rhosili Road, Brackmills,
Northampton NN4 7LZ

sales@johnsonandstarley.co.uk

marketing@johnsonandstarley.co.uk

Reception/Customer Service

01604 762881

Fax

01604 767408

